

## MMBT3904-HF (NPN)

RoHS Device  
Halogen Free

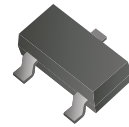

### Features

- Epitaxial planar die construction
- As complementary type, the PNP transistor MMBT3904-HF is recommended

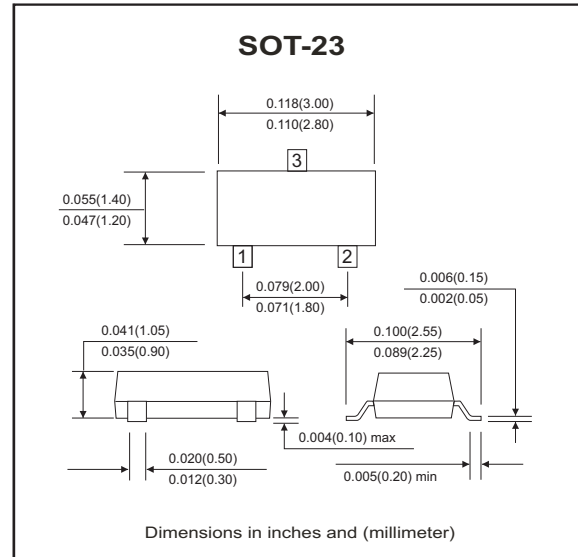
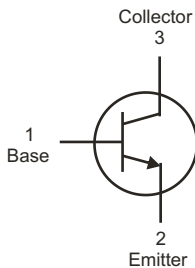

### Maximum Ratings (at TA=25°C unless otherwise noted)

Parameter	Symbol	Min	Typ	Max	Unit
Collector-Base voltage	V <sub>CB0</sub>			60	V
Collector-Emitter voltage	V <sub>CEO</sub>			40	V
Emitter-Base voltage	V <sub>EBO</sub>			6	V
Collector current-Continuous	I <sub>C</sub>			0.2	A
Collector dissipation	P <sub>C</sub>			0.2	W
Thermal resistance, junction to ambient	R <sub>θJA</sub>			625	°C/W
Storage temperature and junction temperature	T <sub>STG</sub> , T <sub>J</sub>	-55		+150	°C

### Electrical Characteristics (at TA=25°C unless otherwise noted)

Parameter	Conditions	Symbol	Min	Max	Unit
Collector-Base breakdown voltage	I <sub>C</sub> = 100μA , I <sub>E</sub> = 0	V <sub>(BR)CBO</sub>	60		V
Collector-Emitter breakdown voltage	I <sub>C</sub> = 1mA , I <sub>B</sub> = 0	V <sub>(BR)CEO</sub>	40		V
Emitter-Base breakdown voltage	I <sub>E</sub> = 100μA , I <sub>C</sub> = 0	V <sub>(BR)EBO</sub>	6		V
Collector cut-off current	V <sub>CB</sub> = 60V , I <sub>E</sub> = 0	I <sub>CB0</sub>		0.1	μA
Collector cut-off current	V <sub>CE</sub> = 30V , V <sub>BE(off)</sub> = 3V	I <sub>CEx</sub>		50	nA
Emitter cut-off current	V <sub>EB</sub> = 5V , I <sub>C</sub> = 0	I <sub>EBO</sub>		0.1	μA
DC current gain	V <sub>CE</sub> = 1V , I <sub>C</sub> = 10mA	h <sub>FE(1)</sub>	100	400	
	V <sub>CE</sub> = 1V , I <sub>C</sub> = 50mA	h <sub>FE(2)</sub>	60		
Collector-Emitter saturation voltage	I <sub>C</sub> = 50mA , I <sub>B</sub> = 5mA	V <sub>CE(sat)</sub>		0.3	V
Base-Emitter saturation voltage	I <sub>C</sub> = 50mA , I <sub>B</sub> = 5mA	V <sub>BE(sat)</sub>		0.95	V
Transition frequency	V <sub>CE</sub> = 20V , I <sub>C</sub> = 10mA f = 100MHz	f <sub>T</sub>	300		Mhz
Delay time	V <sub>CC</sub> = 3.0V , V <sub>BE</sub> = -0.5V	t <sub>d</sub>		35	nS
Rise time	I <sub>C</sub> = 10mA , I <sub>B1</sub> = 1.0mA	t <sub>r</sub>		35	nS
Storage time	V <sub>CC</sub> = 3.0V , I <sub>C</sub> = 10mA	t <sub>s</sub>		200	nS
Fall time	I <sub>B1</sub> = I <sub>B2</sub> = 1.0mA	t <sub>f</sub>		50	nS

## RATING AND CHARACTERISTIC CURVES (MMBT3904-HF)

Fig.1 Typical pulsed current gain V.S. Collector current

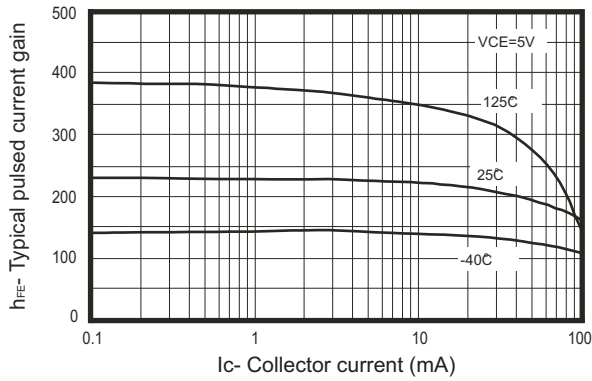

Fig.2 Collector-Emitter saturation voltage V.S. Collector current

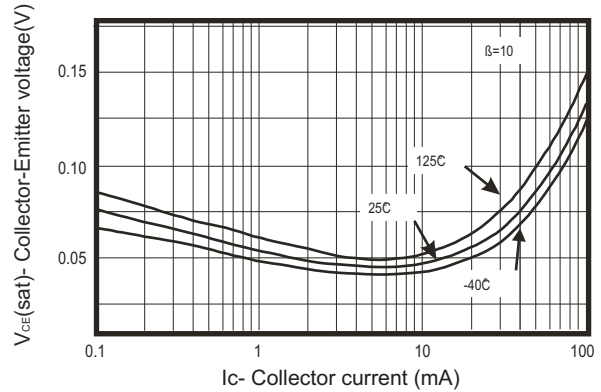

Fig.3 Base-Emitter saturation voltage V.S. Collector current

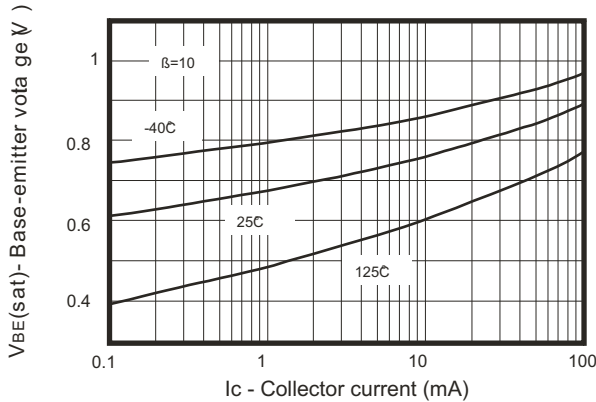

Fig.4 Base-Emitter ON voltage V.S. Collector current

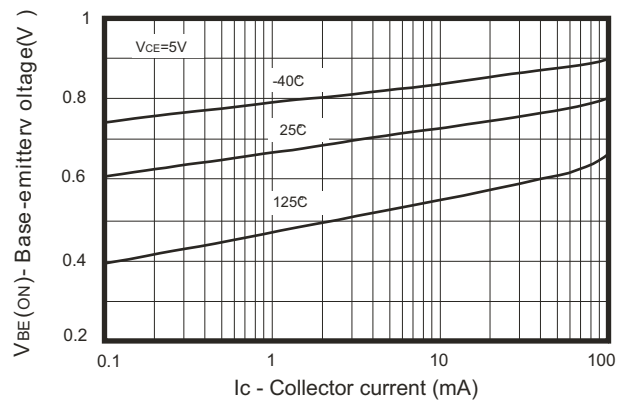

Fig.5 Collector-cutoff current V.S. Ambient temperature

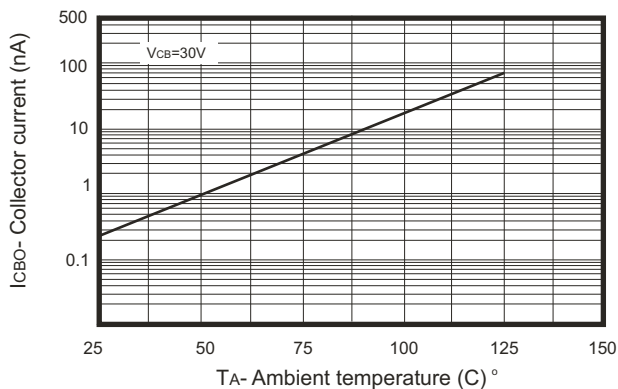
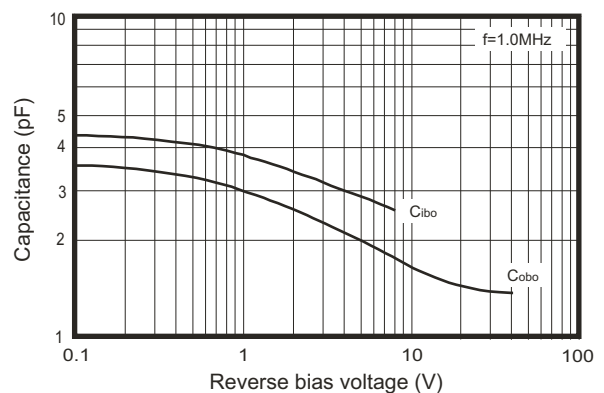
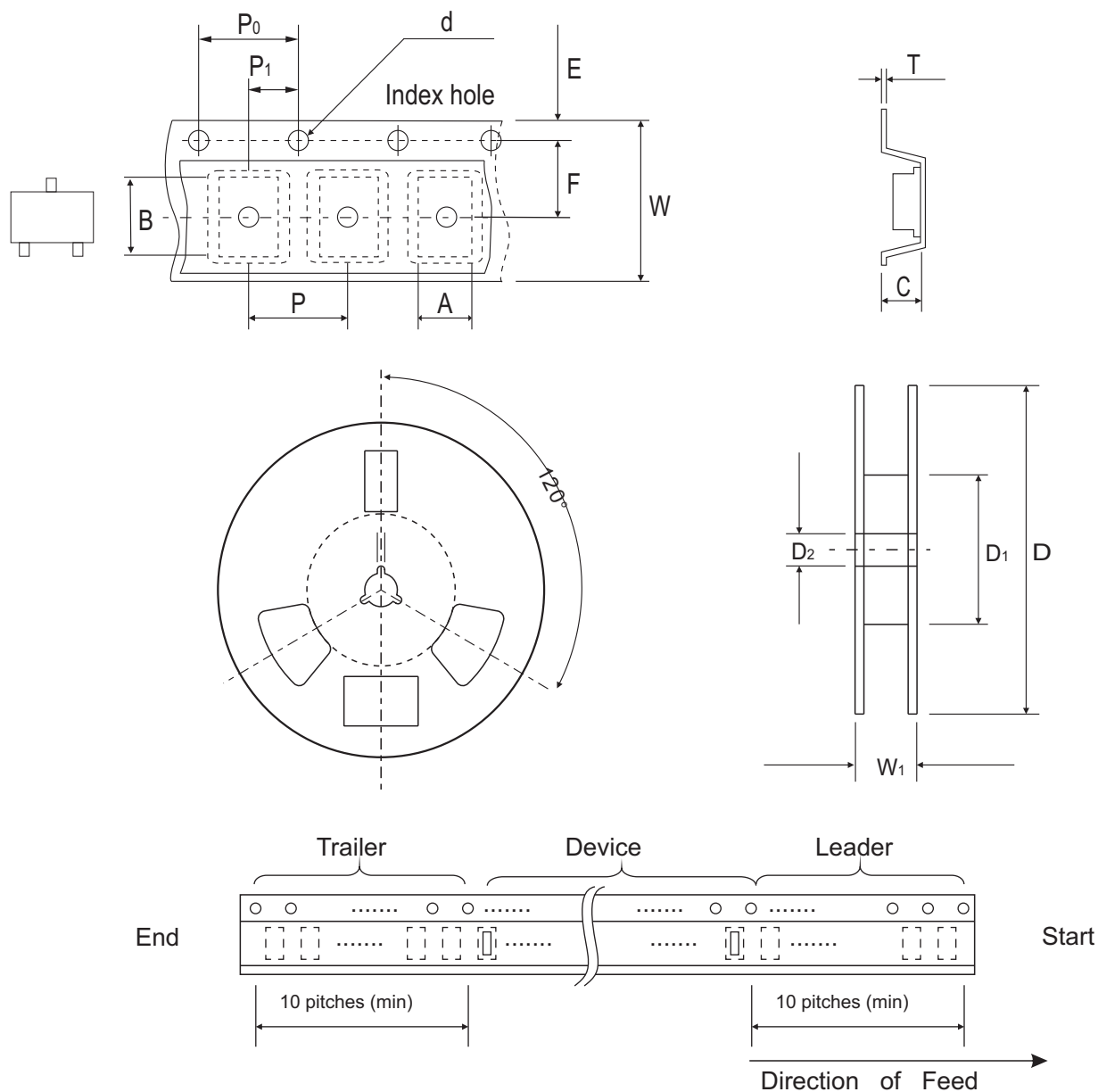

Fig.6 Capacitance V.S. Reverse bias voltage



## Reel Taping Specification



SOT-23	SYMBOL	A	B	C	d	D	D <sub>1</sub>	D <sub>2</sub>
	(mm)	3.10 ± 0.10	2.85 ± 0.10	1.40 ± 0.10	1.55 ± 0.10	178 ± 1	50.0 MIN.	13.0 ± 0.20
	(inch)	0.122 ± 0.004	0.112 ± 0.004	0.055 ± 0.004	0.061 ± 0.004	7.008 ± 0.04	1.969 MIN.	0.512 ± 0.008

SOT-23	SYMBOL	E	F	P	P <sub>0</sub>	P <sub>1</sub>	W	W <sub>1</sub>
	(mm)	1.75 ± 0.10	3.50 ± 0.05	4.00 ± 0.10	4.00 ± 0.10	2.00 ± 0.05	8.00 ± 0.30	14.4 MAX.
	(inch)	0.069 ± 0.004	0.138 ± 0.002	0.157 ± 0.004	0.157 ± 0.004	0.079 ± 0.004	0.315 ± 0.008	0.567 MAX.

## Marking Code

Park Number	Marking Code
MMBT3904-HF	1AM

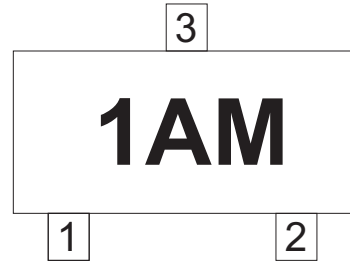

## Suggested PAD Layout

SIZE	SOT-23	
	(mm)	(inch)
A	0.80	0.031
B	0.95	0.037
C	0.95	0.037
D	2.02	0.080
E	3.03	0.120

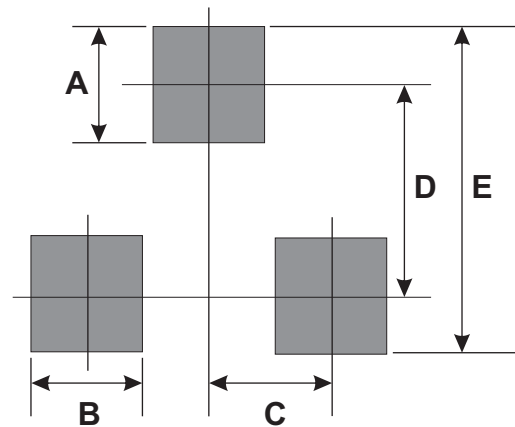

## Standard Packaging

Case Type	Qty per Reel	Reel Size
	(Pcs)	(inch)
SOT-23	3000	7