

## IMPORTANT NOTICE

Dear customer,

As of December 7th, 2015 BL RF Power of NXP Semiconductors will operate as an independent company under the new trade name Ampleon, which will be used in future data sheets together with new contact details.

In data sheets, where the previous Philips references is mentioned, please use the new links as shown below.

<http://www.philips.semiconductors.com> use <http://www.ampleon.com>

<http://www.semiconductors.philips.com> use <http://www.ampleon.com> (Internet)

[sales.addresses@www.semiconductors.philips.com](mailto:sales.addresses@www.semiconductors.philips.com) use  
<http://www.ampleon.com/sales>

The copyright notice at the bottom of each page (or elsewhere in the document, depending on the version)

- © Koninklijke Philips Electronics N.V. (year). All rights reserved -  
is replaced with:

- © Ampleon B.V. (year). All rights reserved. -

If you have any questions related to the data sheet, please contact our nearest sales office (details via <http://www.ampleon.com/sales>).

Thank you for your cooperation and understanding,

Ampleon

# VHF power MOS transistor

# BLF244

### FEATURES

- High power gain
- Low noise figure
- Easy power control
- Good thermal stability
- Withstands full load mismatch
- Gold metallization ensures excellent reliability.

### DESCRIPTION

Silicon N-channel enhancement mode vertical D-MOS transistor designed for large signal amplifier applications in the VHF frequency range.

The transistor is encapsulated in a 4-lead SOT123A flange package, with a ceramic cap. All leads are isolated from the flange.

Matched gate-source voltage ( $V_{GS}$ ) groups are available on request.

### PINNING - SOT123A

PIN	DESCRIPTION
1	drain
2	source
3	gate
4	source

### PIN CONFIGURATION

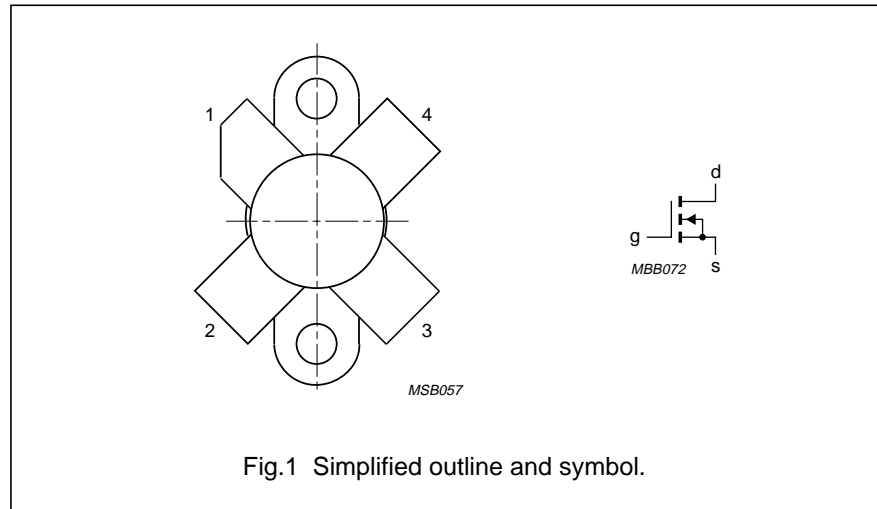

**CAUTION**

This product is supplied in anti-static packing to prevent damage caused by electrostatic discharge during transport and handling. For further information, refer to Philips specs.: SNW-EQ-608, SNW-FQ-302A, and SNW-FQ-302B.

**WARNING**

**Product and environmental safety - toxic materials**

This product contains beryllium oxide. The product is entirely safe provided that the BeO disc is not damaged. All persons who handle, use or dispose of this product should be aware of its nature and of the necessary safety precautions. After use, dispose of as chemical or special waste according to the regulations applying at the location of the user. It must never be thrown out with the general or domestic waste.

### QUICK REFERENCE DATA

RF performance at  $T_h = 25\text{ }^\circ\text{C}$  in a common source test circuit.

MODE OF OPERATION	f (MHz)	$V_{DS}$ (V)	PL (W)	$G_p$ (dB)	$\eta_D$ (%)
CW, class-B	175	28	15	>13	>50

VHF power MOS transistor

BLF244

**LIMITING VALUES**

In accordance with the Absolute Maximum Rating System (IEC 60134).

SYMBOL	PARAMETER	CONDITIONS	MIN.	MAX.	UNIT
$V_{DS}$	drain-source voltage		–	65	V
$V_{GS}$	gate-source voltage		–	$\pm 20$	V
$I_D$	drain current (DC)		–	3	A
$P_{tot}$	total power dissipation	$T_{mb} \leq 25\text{ }^\circ\text{C}$	–	38	W
$T_{stg}$	storage temperature		–65	150	$^\circ\text{C}$
$T_j$	junction temperature		–	200	$^\circ\text{C}$

**THERMAL CHARACTERISTICS**

SYMBOL	PARAMETER	CONDITIONS	VALUE	UNIT
$R_{th\ j-mb}$	thermal resistance from junction to mounting base	$T_{mb} = 25\text{ }^\circ\text{C}; P_{tot} = 38\text{ W}$	4.6	K/W
$R_{th\ mb-h}$	thermal resistance from mounting base to heatsink	$T_{mb} = 25\text{ }^\circ\text{C}; P_{tot} = 38\text{ W}$	0.3	K/W

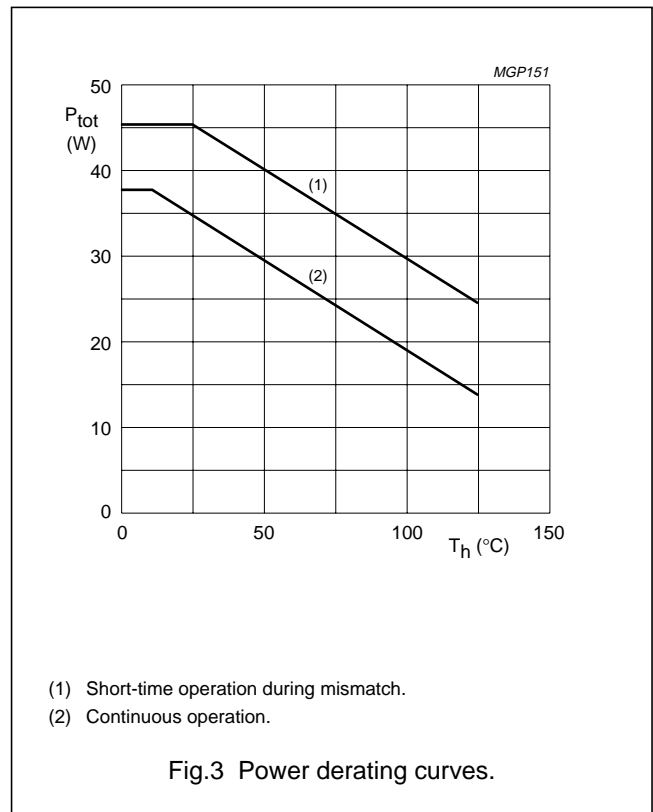
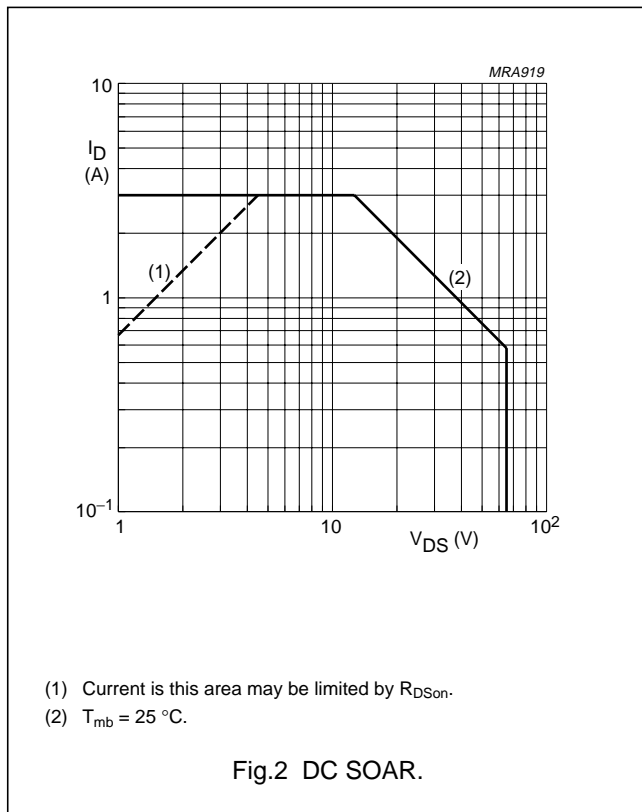

## VHF power MOS transistor

BLF244

## CHARACTERISTICS

 $T_j = 25\text{ °C}$  unless otherwise specified.

SYMBOL	PARAMETER	CONDITIONS	MIN.	TYP.	MAX.	UNIT
$V_{(BR)DSS}$	drain-source breakdown voltage	$V_{GS} = 0$ ; $I_D = 5\text{ mA}$	65	–	–	V
$I_{DSS}$	drain-source leakage current	$V_{GS} = 0$ ; $V_{DS} = 28\text{ V}$	–	–	1	mA
$I_{GSS}$	gate-source leakage current	$V_{GS} = \pm 20\text{ V}$ ; $V_{DS} = 0$	–	–	1	$\mu\text{A}$
$V_{GSth}$	gate-source threshold voltage	$I_D = 5\text{ mA}$ ; $V_{DS} = 10\text{ V}$	2	–	4.5	V
$\Delta V_{GS}$	gate-source voltage difference of matched devices	$I_D = 5\text{ mA}$ ; $V_{DS} = 10\text{ V}$	–	–	100	mV
$g_{fs}$	forward transconductance	$I_D = 0.75\text{ A}$ ; $V_{DS} = 10\text{ V}$	0.6	–	–	S
$R_{DSon}$	drain-source on-state resistance	$I_D = 0.75\text{ A}$ ; $V_{GS} = 10\text{ V}$	–	0.8	1.5	$\Omega$
$I_{DSX}$	on-state drain current	$V_{GS} = 10\text{ V}$ ; $V_{DS} = 10\text{ V}$	–	5	–	A
$C_{is}$	input capacitance	$V_{GS} = 0$ ; $V_{DS} = 28\text{ V}$ ; $f = 1\text{ MHz}$	–	60	–	pF
$C_{os}$	output capacitance	$V_{GS} = 0$ ; $V_{DS} = 28\text{ V}$ ; $f = 1\text{ MHz}$	–	40	–	pF
$C_{rs}$	feedback capacitance	$V_{GS} = 0$ ; $V_{DS} = 28\text{ V}$ ; $f = 1\text{ MHz}$	–	4.5	–	pF
F	noise figure; see Fig.13	$I_D = 0.5\text{ A}$ ; $V_{DS} = 28\text{ V}$ ; $R_1 = 23\ \Omega$ ; $T_h = 25\text{ °C}$ ; $f = 175\text{ MHz}$ ; $R_{th\ mb-h} = 0.3\text{ K/W}$	–	4.3	–	dB

 $V_{GS}$  group indicator

GROUP	LIMITS (V)		GROUP	LIMITS (V)	
	MIN.	MAX.		MIN.	MAX.
A	2.0	2.1	O	3.3	3.4
B	2.1	2.2	P	3.4	3.5
C	2.2	2.3	Q	3.5	3.6
D	2.3	2.4	R	3.6	3.7
E	2.4	2.5	S	3.7	3.8
F	2.5	2.6	T	3.8	3.9
G	2.6	2.7	U	3.9	4.0
H	2.7	2.8	V	4.0	4.1
J	2.8	2.9	W	4.1	4.2
K	2.9	3.0	X	4.2	4.3
L	3.0	3.1	Y	4.3	4.4
M	3.1	3.2	Z	4.4	4.5
N	3.2	3.3			

VHF power MOS transistor

BLF244

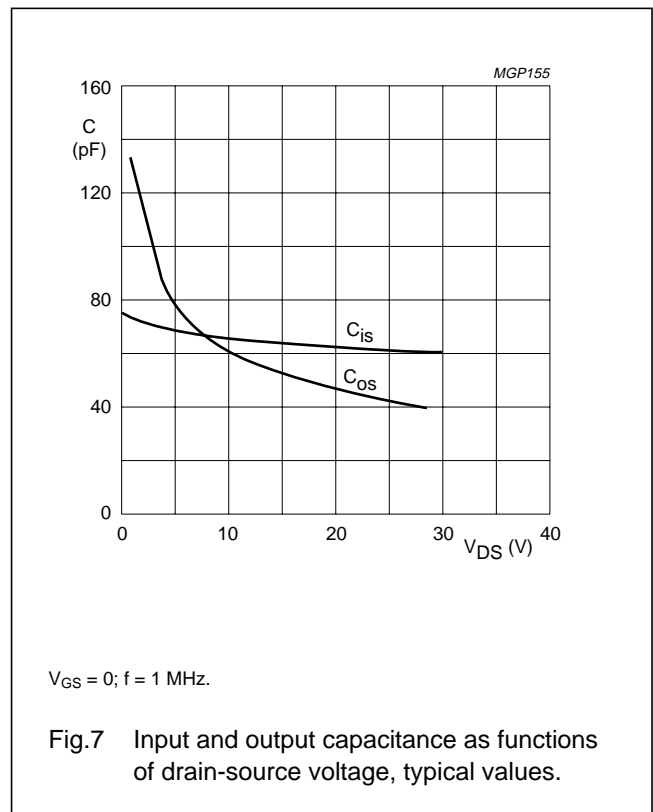
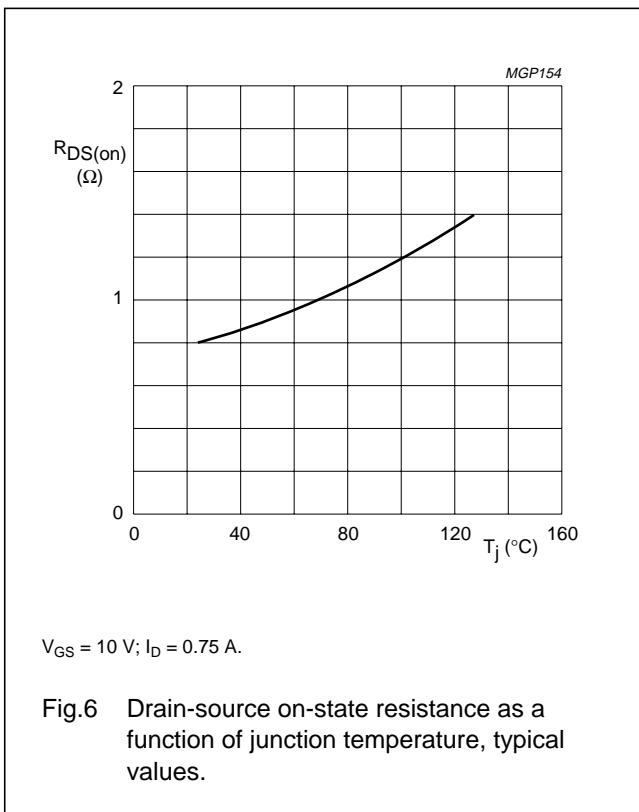
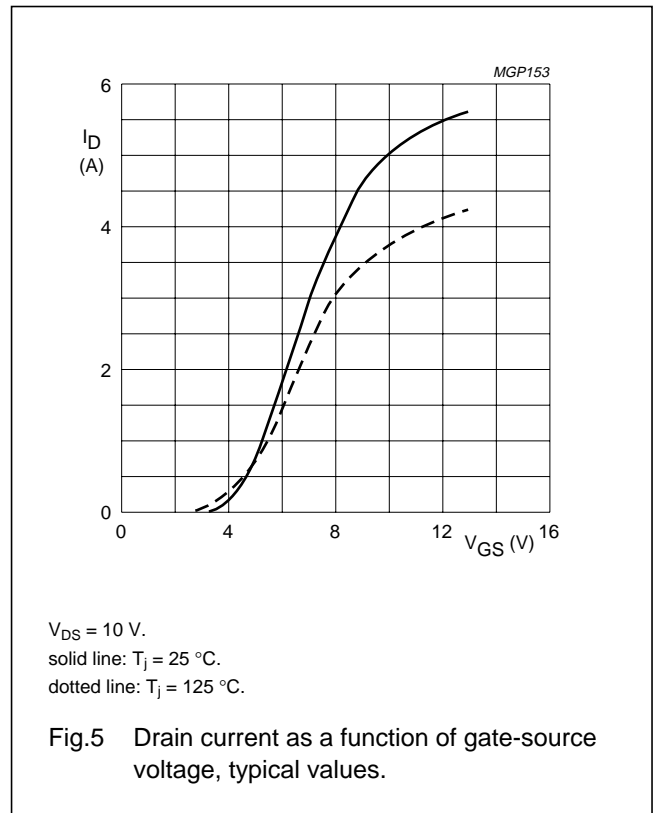
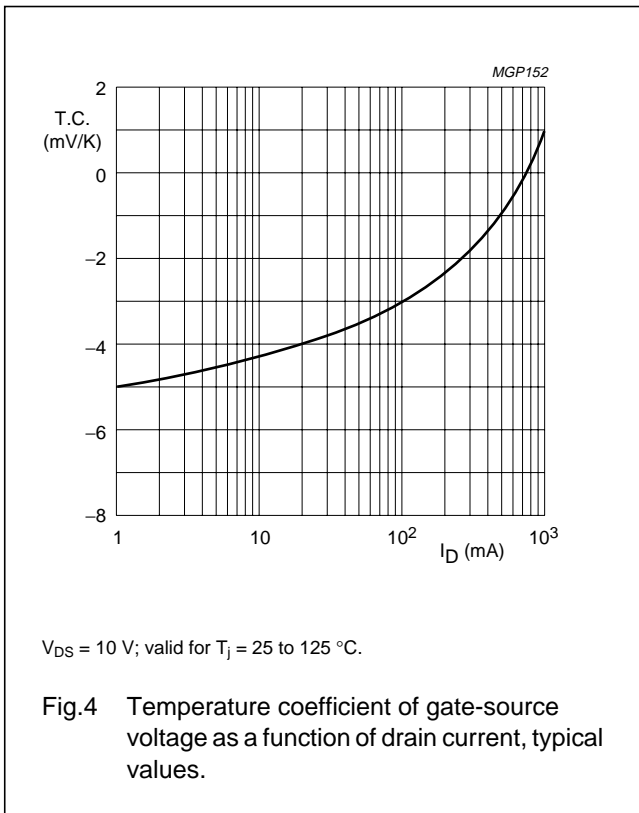

VHF power MOS transistor

BLF244

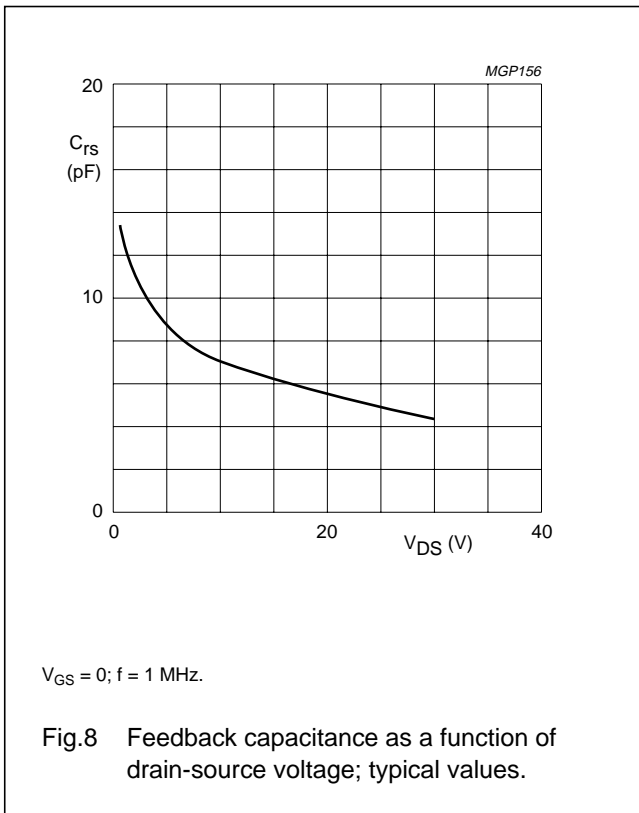

**APPLICATION INFORMATION FOR CLASS-B OPERATION**

$T_h = 25 \text{ }^\circ\text{C}$ ;  $R_{th\ mb-h} = 3 \text{ K/W}$ ; unless otherwise specified.

RF performance in CW operation in a common source class-B circuit.

MODE OF OPERATION	f (MHz)	$V_{DS}$ (V)	$I_{DQ}$ (mA)	$P_L$ (W)	$G_P$ (dB)	$\eta_D$ (%)	$Z_i$ ( $\Omega$ ) <sup>(1)</sup>	$Z_L$ ( $\Omega$ )	R1 ( $\Omega$ )
CW, class-B	175	28	25	15	>13 typ. 17	>50 typ. 65	3.0 – j4.0	6.3 + j9.8	46.4//46.4
	175	12.5	25	6	typ. 15	typ. 60	3.0 – j4.0	4.5 + j3.3	100

**Note**

1. R1 included.

**Ruggedness in class-B operation**

The BLF244 is capable of withstanding a load mismatch corresponding to  $V_{SWR} = 50$  through all phases under the following conditions:  $T_h = 25 \text{ }^\circ\text{C}$ ;  $R_{th\ mb-h} = 0.3 \text{ K/W}$ ; at rated load power.

VHF power MOS transistor

BLF244

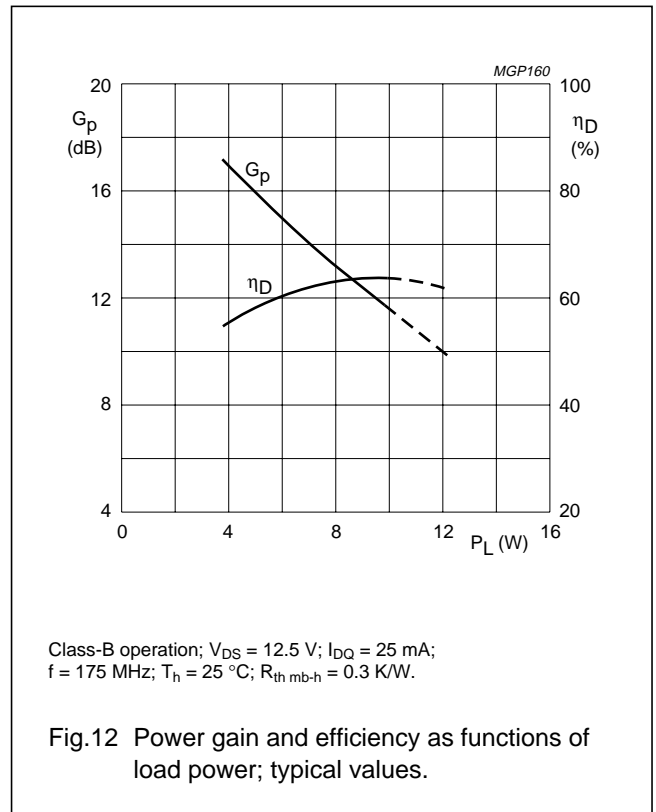
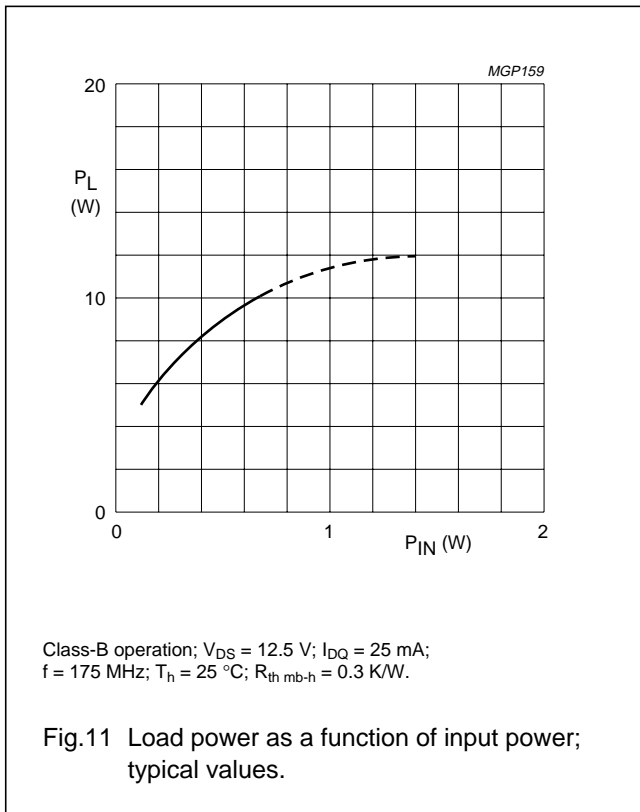
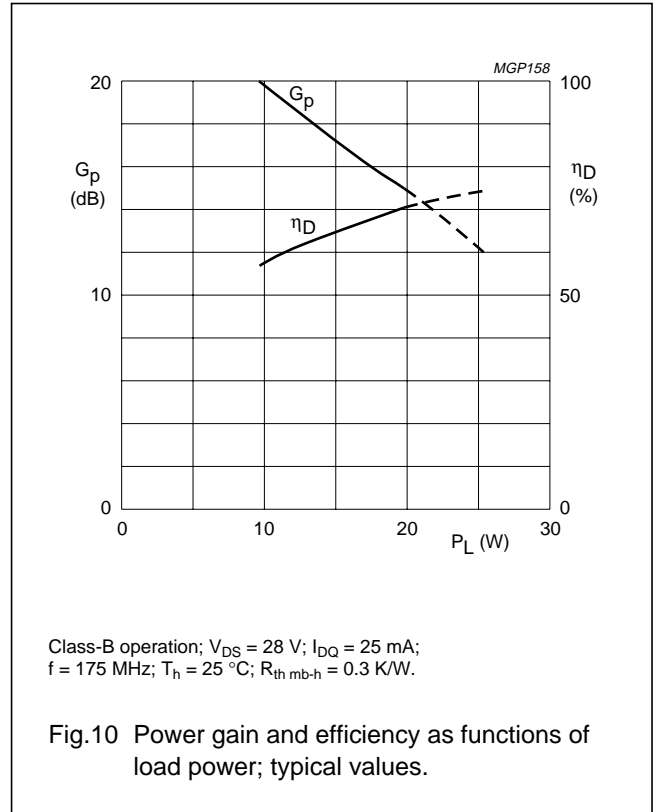
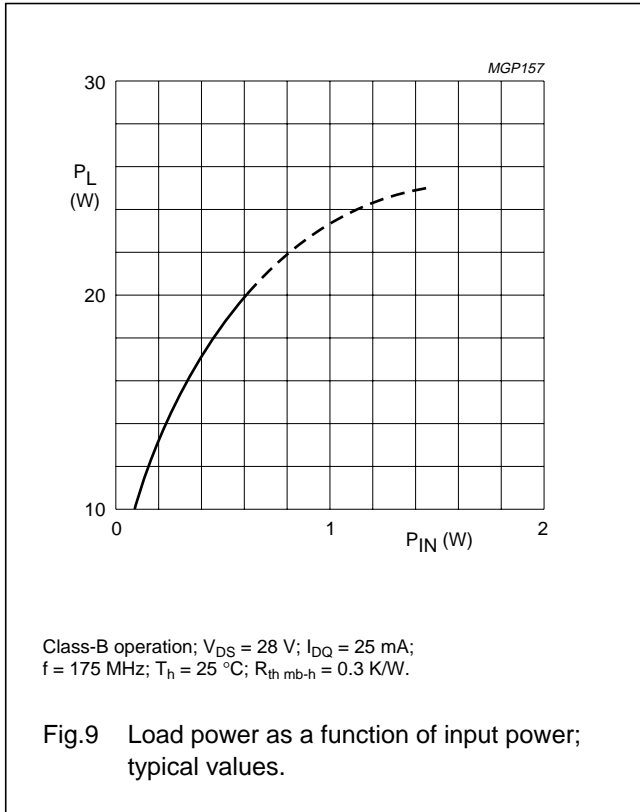

VHF power MOS transistor

BLF244

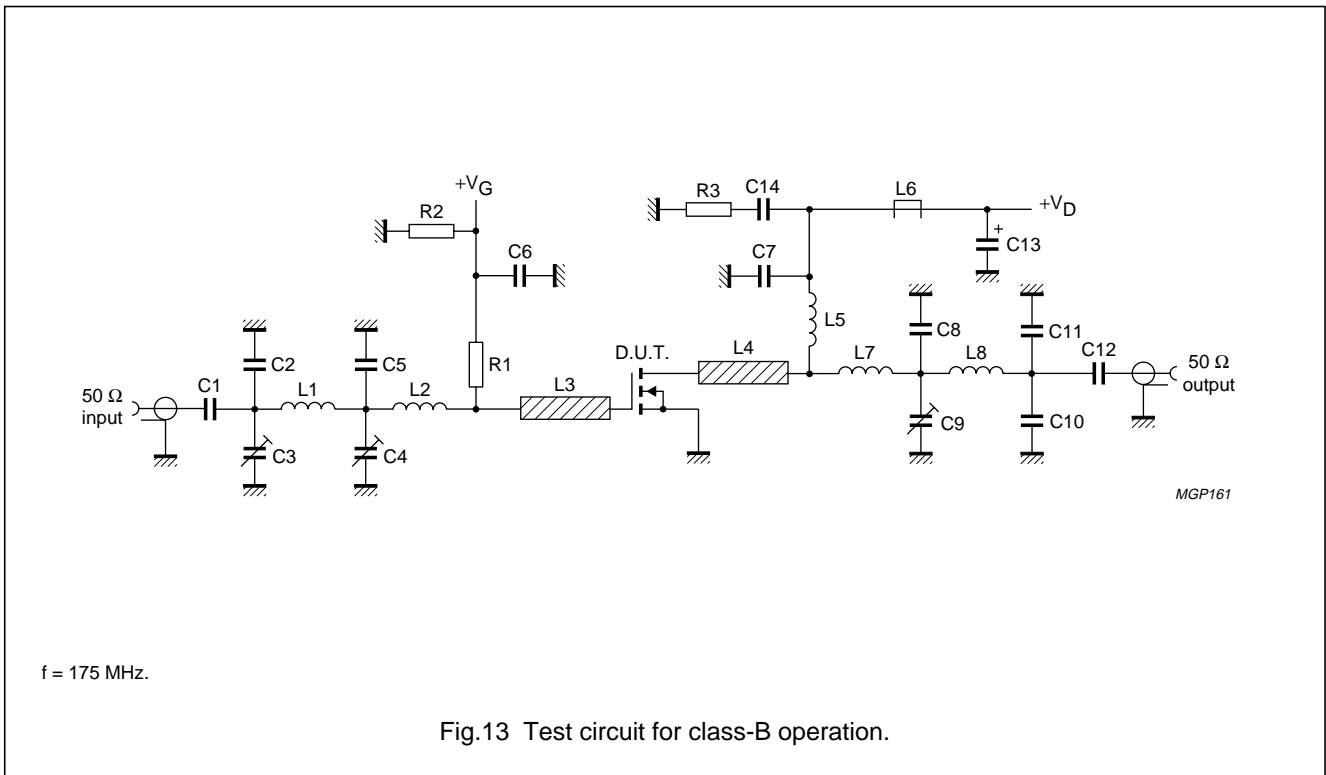

Fig.13 Test circuit for class-B operation.



## VHF power MOS transistor

BLF244

## List of components (see Fig.13)

COMPONENT	DESCRIPTION	VALUE	DIMENSIONS	CATALOGUE NO.
C1, C12	multilayer ceramic chip capacitor; note 1	680 nF		
C2	multilayer ceramic chip capacitor; note 1	20 pF		
C3, C4, C9	film dielectric trimmer	5 to 60 pF		2222 809 08003
C5	multilayer ceramic chip capacitor; note 1	75 pF		
C6	multilayer ceramic chip capacitor	10 nF		2222 852 47103
C7	multilayer ceramic chip capacitor; note 1	100 pF		
C8	multilayer ceramic chip capacitor; note 1	47 pF		
C10, C11	multilayer ceramic chip capacitor; note 1	11 pF		
C13	solid tantalum capacitor	2.2 $\mu$ F		
C14	multilayer ceramic chip capacitor	100 nF		2222 852 47104
L1	4 turns enamelled 1 mm copper wire	32 nH	length 6.3 mm int. dia. 3 mm leads 2 $\times$ 5 mm	
L2	1 turn enamelled 1 mm copper wire	12.2 nH	int. dia. 5.6 mm leads 2 $\times$ 5 mm	
L3, L4	stripline; note 2	30 $\Omega$	15 $\times$ 6 mm	
L5	6 turns enamelled 1 mm copper wire	119 nH	length 10.4 mm int. dia. 6 mm leads 2 $\times$ 5 mm	
L6	grade 3B Ferroxcube RF choke			4312 020 36640
L7	2 turns enamelled 1 mm copper wire	19 nH	length 2.4 mm int. dia. 3 mm leads 2 $\times$ 5 mm	
L8	4 turns enamelled 1 mm copper wire	28.5 nH	length 8.5 mm int. dia. 3 mm leads 2 $\times$ 5 mm	
R1	metal film resistor; note 3			
R2	0.4 W metal film resistor	1 M $\Omega$		
R3	0.4 W metal film resistor	10 $\Omega$		

## Notes

- American Technical Ceramics (ATC) capacitor, type 100B or other capacitor of the same quality.
- The striplines are on a double copper-clad printed circuit board, with epoxy fibre-glass dielectric ( $\epsilon_r = 4.5$ ), thickness  $\frac{1}{16}$  inch.
- Refer to Application Information for value.

VHF power MOS transistor

BLF244

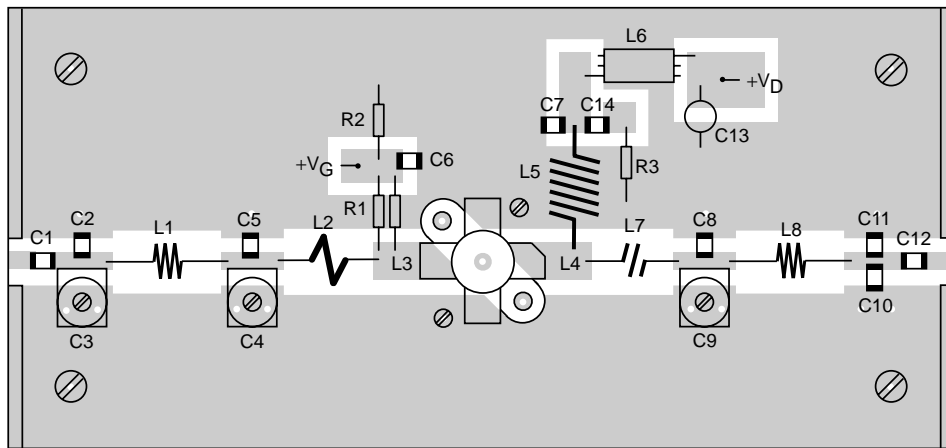
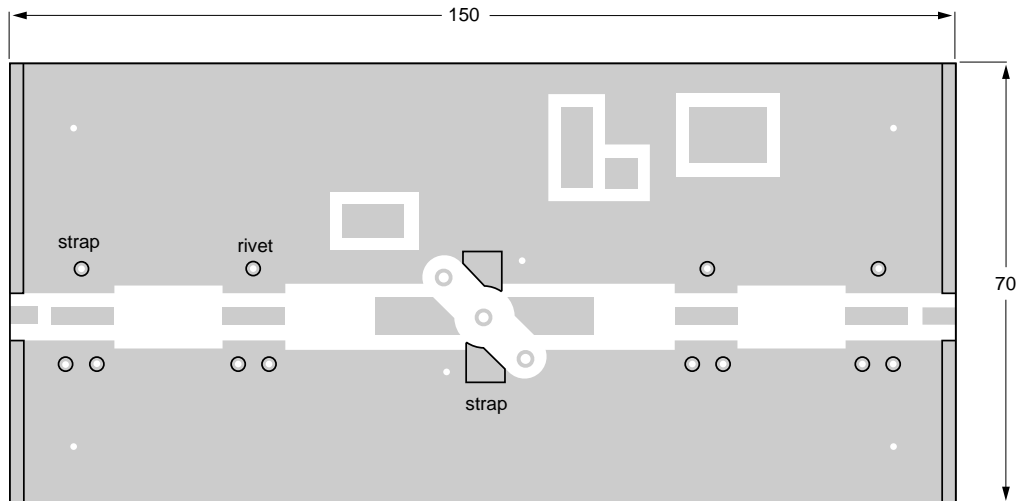

MGP162

Dimensions in mm.

The circuit and components are situated on one side of the epoxy fibre-glass board, the other side being unetched copper to serve as ground plane. Earth connections are made by fixing screws, copper straps and hollow rivets under the sources and around the edges to provide a direct contact between the copper on the component side and the ground plane.

Fig.14 Component layout for 175 MHz class-B test circuit.

VHF power MOS transistor

BLF244

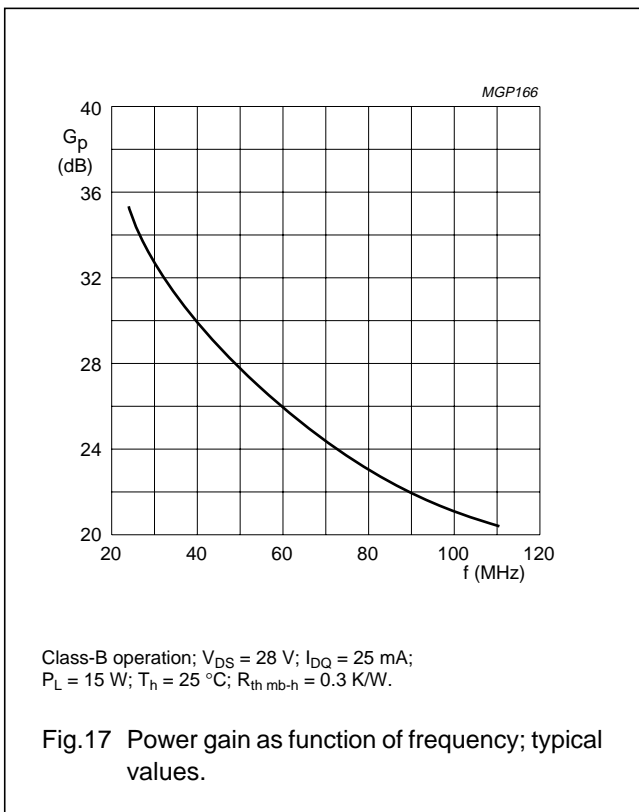
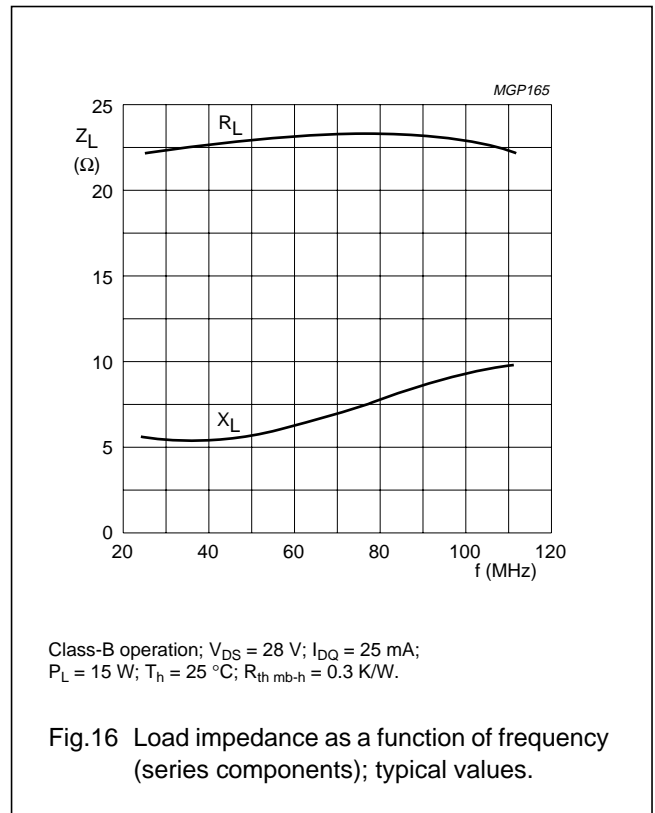
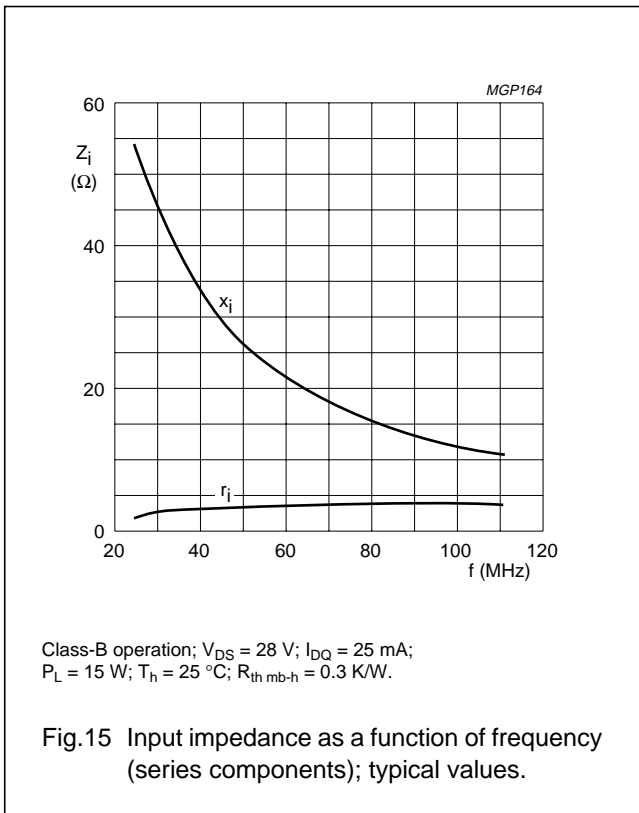

## VHF power MOS transistor

## BLF244

**BLF244 scattering parameters** $V_{DS} = 12.5\text{ V}$ ;  $I_D = 25\text{ mA}$ ; note 1

f (MHz)	S <sub>11</sub>		S <sub>21</sub>		S <sub>12</sub>		S <sub>22</sub>	
	S <sub>11</sub>	∠ Φ	S <sub>21</sub>	∠ Φ	S <sub>12</sub>	∠ Φ	S <sub>22</sub>	∠ Φ
5	0.98	-18.6	15.11	165.1	0.02	75.8	0.98	-18.9
10	0.93	-35.0	14.06	152.3	0.04	63.1	0.95	-36.5
20	0.84	-63.4	11.55	130.0	0.06	42.1	0.86	-65.1
30	0.77	-83.3	9.20	114.5	0.07	27.3	0.80	-85.7
40	0.73	-97.6	7.41	102.8	0.07	16.5	0.76	-99.8
50	0.72	-107.9	6.09	93.7	0.07	8.5	0.74	-109.8
60	0.71	-115.7	5.09	86.2	0.07	2.0	0.74	-117.3
70	0.72	-121.4	4.32	80.1	0.07	-3.1	0.74	-123.1
80	0.72	-126.0	3.72	74.8	0.07	-7.2	0.75	-127.8
90	0.74	-130.0	3.26	70.1	0.006	-10.9	0.76	-131.9
100	0.75	-133.8	2.88	65.6	0.06	-14.3	0.78	-135.4
125	0.78	-142.0	2.16	55.5	0.05	-20.6	0.81	-142.4
150	0.81	-147.9	1.66	48.1	0.04	-22.9	0.84	-147.8
175	0.85	-152.7	1.33	42.2	0.03	-21.0	0.86	-152.4
200	0.87	-157.6	1.09	36.7	0.02	-12.8	0.88	-156.4
250	0.90	-165.1	0.75	28.8	0.01	46.1	0.92	-162.9
300	0.92	-171.5	0.56	23.8	0.03	80.9	0.94	-168.1
350	0.94	-176.8	0.42	21.4	0.04	88.3	0.95	-172.4
400	0.94	178.3	0.34	20.8	0.06	89.0	0.96	-176.2
450	0.95	174.0	0.28	21.9	0.07	88.8	0.96	-179.6
500	0.95	169.9	0.24	24.8	0.09	86.9	0.96	177.3
600	0.95	162.4	0.19	33.8	0.12	83.5	0.97	171.8
700	0.94	155.4	0.18	42.8	0.14	79.9	0.96	166.8
800	0.94	148.6	0.19	50.1	0.17	77.1	0.96	162.1
900	0.93	142.0	0.21	54.4	0.19	71.6	0.94	157.9
1000	0.92	135.5	0.23	59.6	0.22	73.5	0.93	162.9

**Note**

1. For more extensive s-parameters see internet:  
<http://www.semiconductors.philips.com/markets/communications/wirelesscommunication/broadcast>.

## VHF power MOS transistor

## BLF244

**BLF244 scattering parameters** $V_{DS} = 28\text{ V}$ ;  $I_D = 25\text{ mA}$ ; note 1

f (MHz)	S <sub>11</sub>		S <sub>21</sub>		S <sub>12</sub>		S <sub>22</sub>	
	S <sub>11</sub>	∠ Φ	S <sub>21</sub>	∠ Φ	S <sub>12</sub>	∠ Φ	S <sub>22</sub>	∠ Φ
5	0.99	-15.9	15.62	167.8	0.01	78.5	0.98	-13.8
10	0.96	-30.1	14.85	157.2	0.03	68.0	0.96	-27.1
20	0.89	-56.5	12.92	137.3	0.04	49.3	0.88	-50.1
30	0.83	-76.5	10.79	122.3	0.06	35.1	0.81	-68.2
40	0.79	-91.7	8.98	110.5	0.06	24.1	0.76	-81.7
50	0.77	-103.1	7.55	101.1	0.06	15.8	0.73	-91.9
60	0.76	-111.8	6.40	93.4	0.06	9.1	0.72	-99.9
70	0.75	-118.3	5.50	87.1	0.06	3.8	0.72	-106.4
80	0.76	-123.5	4.79	81.7	0.06	-0.5	0.72	-111.8
90	0.76	-127.9	4.24	76.8	0.06	-4.3	0.73	-116.6
100	0.77	-132.0	3.77	72.2	0.06	-7.7	0.74	-120.8
125	0.79	-140.7	2.88	61.9	0.05	-14.3	0.77	-129.3
150	0.82	-146.7	2.24	54.2	0.04	-16.8	0.80	-135.8
175	0.85	-151.6	1.82	47.9	0.03	-15.2	0.83	-141.4
200	0.87	-156.5	1.50	42.0	0.02	-7.5	0.85	-146.3
250	0.89	-164.0	1.04	33.2	0.01	48.5	0.89	-154.2
300	0.92	-170.5	0.78	27.0	0.03	83.8	0.92	-160.5
350	0.93	-175.8	0.59	23.1	0.04	91.3	0.93	-165.7
400	0.94	179.1	0.47	20.9	0.06	91.9	0.95	-170.1
450	0.95	174.8	0.38	20.0	0.07	91.5	0.95	-174.1
500	0.94	170.7	0.32	20.8	0.09	89.4	0.96	-177.6
600	0.94	163.1	0.25	26.1	0.12	85.7	0.96	176.1
700	0.94	156.0	0.22	33.7	0.14	81.9	0.96	170.6
800	0.93	149.2	0.21	41.9	0.17	78.9	0.96	165.5
900	0.93	142.5	0.22	47.9	0.19	73.1	0.94	160.9
1000	0.92	136.1	0.23	57.3	0.17	75.3	0.93	165.9

**Note**

- For more extensive s-parameters see internet:  
<http://www.semiconductors.philips.com/markets/communications/wirelesscommunication/broadcast>.

VHF power MOS transistor

BLF244

PACKAGE OUTLINE

Flanged ceramic package; 2 mounting holes; 4 leads

SOT123A

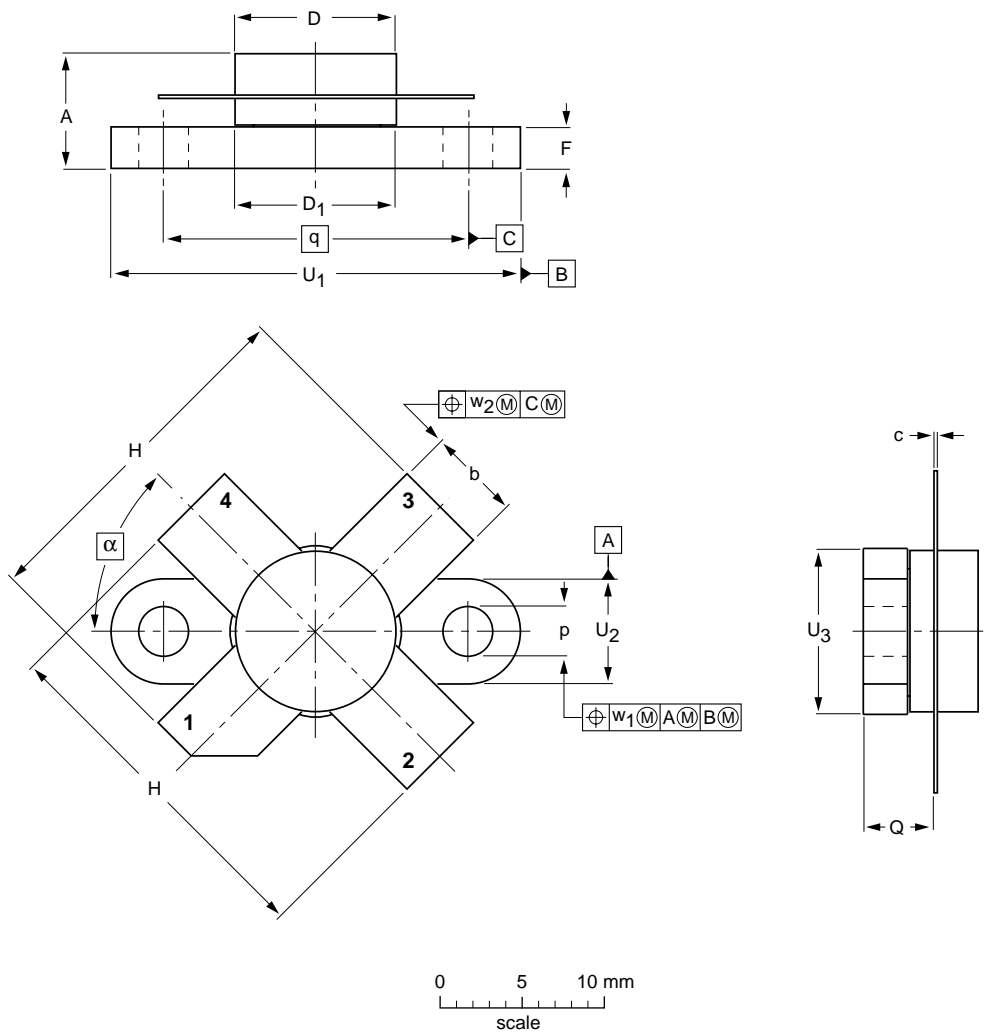

DIMENSIONS (millimetre dimensions are derived from the original inch dimensions)

UNIT	A	b	c	D	D <sub>1</sub>	F	H	p	Q	q	U <sub>1</sub>	U <sub>2</sub>	U <sub>3</sub>	w <sub>1</sub>	w <sub>2</sub>	α
mm	7.47 6.37	5.82 5.56	0.18 0.10	9.73 9.47	9.78 9.42	2.72 2.31	20.71 19.93	3.33 3.04	4.63 4.11	18.42	24.87 24.64	6.48 6.22	9.78 9.39	0.25	0.51	45°
inches	0.294 0.251	0.229 0.219	0.007 0.004	0.383 0.373	0.385 0.371	0.107 0.091	0.815 0.785	0.131 0.120	0.182 0.162	0.725	0.980 0.970	0.255 0.245	0.385 0.370	0.010	0.020	

OUTLINE VERSION	REFERENCES				EUROPEAN PROJECTION	ISSUE DATE
	IEC	JEDEC	EIAJ			
SOT123A						99-03-29

## VHF power MOS transistor

BLF244

## DATA SHEET STATUS

LEVEL	DATA SHEET STATUS <sup>(1)</sup>	PRODUCT STATUS <sup>(2)(3)</sup>	DEFINITION
I	Objective data	Development	This data sheet contains data from the objective specification for product development. Philips Semiconductors reserves the right to change the specification in any manner without notice.
II	Preliminary data	Qualification	This data sheet contains data from the preliminary specification. Supplementary data will be published at a later date. Philips Semiconductors reserves the right to change the specification without notice, in order to improve the design and supply the best possible product.
III	Product data	Production	This data sheet contains data from the product specification. Philips Semiconductors reserves the right to make changes at any time in order to improve the design, manufacturing and supply. Relevant changes will be communicated via a Customer Product/Process Change Notification (CPCN).

## Notes

1. Please consult the most recently issued data sheet before initiating or completing a design.
2. The product status of the device(s) described in this data sheet may have changed since this data sheet was published. The latest information is available on the Internet at URL <http://www.semiconductors.philips.com>.
3. For data sheets describing multiple type numbers, the highest-level product status determines the data sheet status.

## DEFINITIONS

**Short-form specification** — The data in a short-form specification is extracted from a full data sheet with the same type number and title. For detailed information see the relevant data sheet or data handbook.

**Limiting values definition** — Limiting values given are in accordance with the Absolute Maximum Rating System (IEC 60134). Stress above one or more of the limiting values may cause permanent damage to the device. These are stress ratings only and operation of the device at these or at any other conditions above those given in the Characteristics sections of the specification is not implied. Exposure to limiting values for extended periods may affect device reliability.

**Application information** — Applications that are described herein for any of these products are for illustrative purposes only. Philips Semiconductors make no representation or warranty that such applications will be suitable for the specified use without further testing or modification.

## DISCLAIMERS

**Life support applications** — These products are not designed for use in life support appliances, devices, or systems where malfunction of these products can reasonably be expected to result in personal injury. Philips Semiconductors customers using or selling these products for use in such applications do so at their own risk and agree to fully indemnify Philips Semiconductors for any damages resulting from such application.

**Right to make changes** — Philips Semiconductors reserves the right to make changes in the products - including circuits, standard cells, and/or software - described or contained herein in order to improve design and/or performance. When the product is in full production (status 'Production'), relevant changes will be communicated via a Customer Product/Process Change Notification (CPCN). Philips Semiconductors assumes no responsibility or liability for the use of any of these products, conveys no licence or title under any patent, copyright, or mask work right to these products, and makes no representations or warranties that these products are free from patent, copyright, or mask work right infringement, unless otherwise specified.

# *Philips Semiconductors – a worldwide company*

## **Contact information**

For additional information please visit <http://www.semiconductors.philips.com>. Fax: +31 40 27 24825

For sales offices addresses send e-mail to: [sales.addresses@www.semiconductors.philips.com](mailto:sales.addresses@www.semiconductors.philips.com).

© Koninklijke Philips Electronics N.V. 2003

SCA75

All rights are reserved. Reproduction in whole or in part is prohibited without the prior written consent of the copyright owner.

The information presented in this document does not form part of any quotation or contract, is believed to be accurate and reliable and may be changed without notice. No liability will be accepted by the publisher for any consequence of its use. Publication thereof does not convey nor imply any license under patent- or other industrial or intellectual property rights.

Printed in The Netherlands

613524/03/pp16

Date of release: 2003 Oct 13

Document order number: 9397 750 11584

*Let's make things better.*

**Philips  
Semiconductors**



**PHILIPS**