

Atmel[®]

Atmel Technology Live
SAM D

Atmel[®] | SMART[™] ARM[®] Cortex-M0+ based MCU

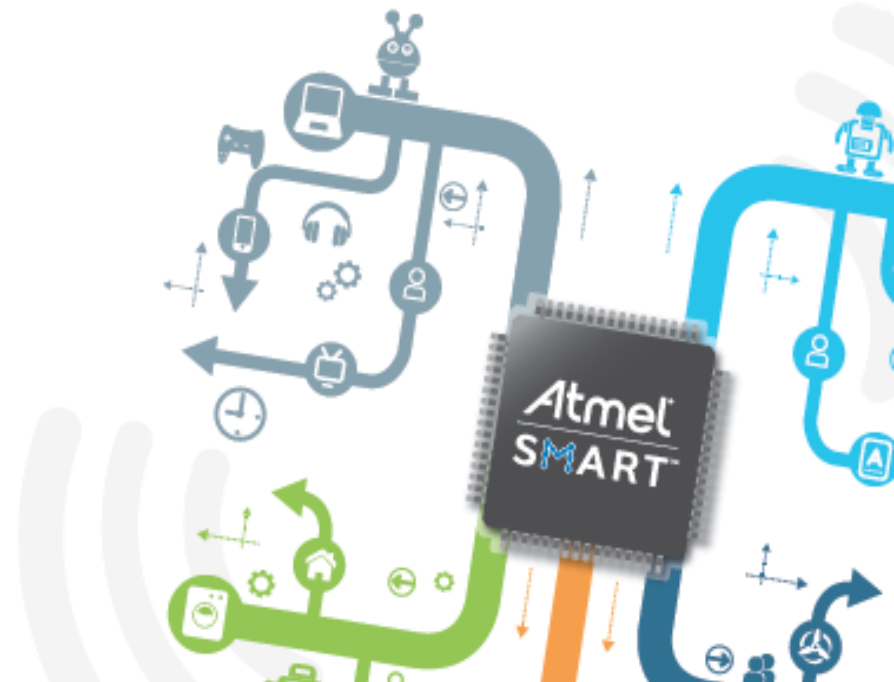

Atmel | SMART™ MCU Product Offering

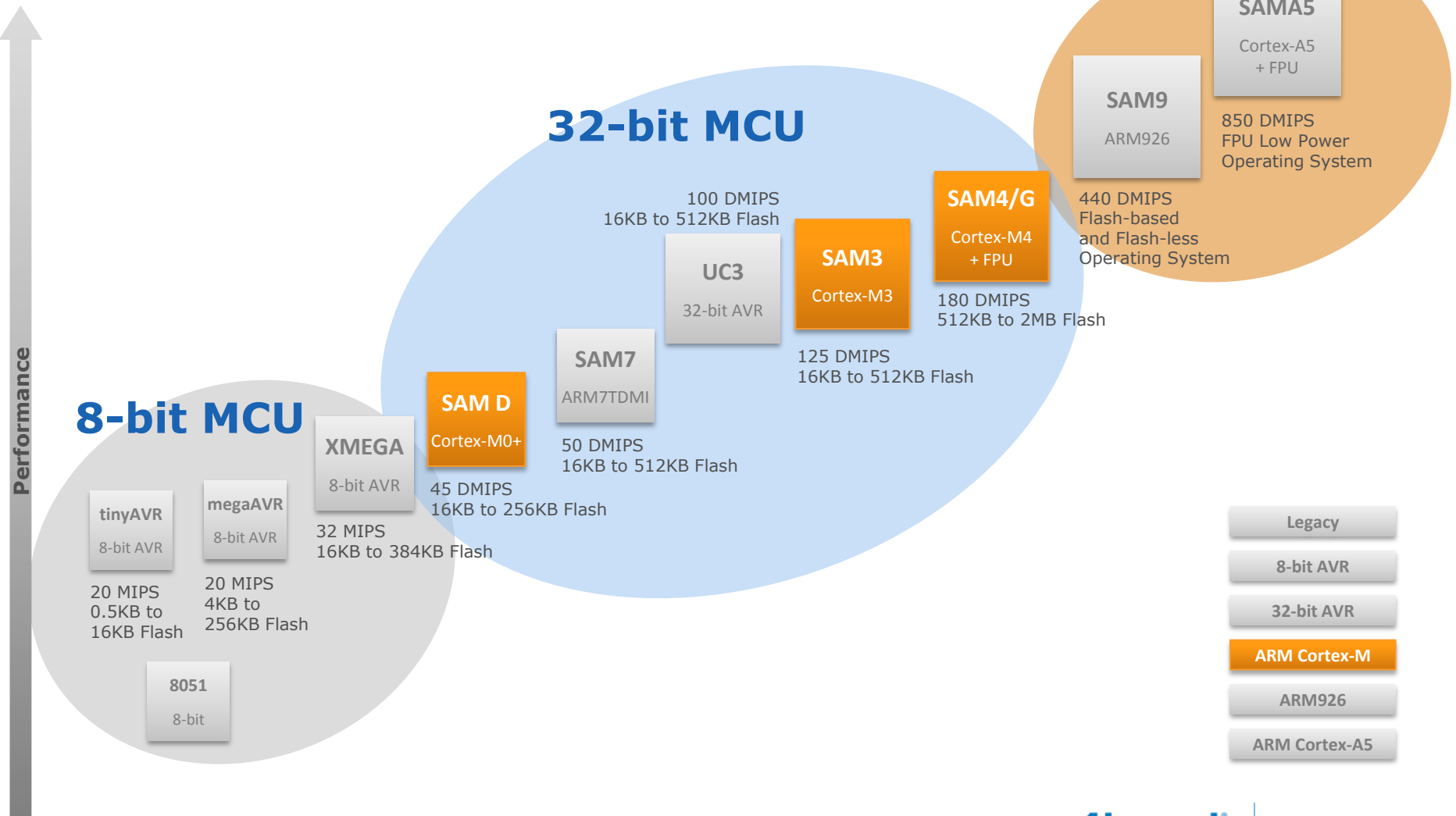

Atmel | SMART™ ARM Cortex based 32-bit MCU

Flash: 8kB to 2MB – Package: 14 to 144 pins

M0+	M3/M4	M3	M4	M4F	M3	M3	M4F	M4	M4F
48MHz	..100MHz	64MHz	120MHz	120MHz	96MHz	84MHz	120MHz	48MHz	48MHz

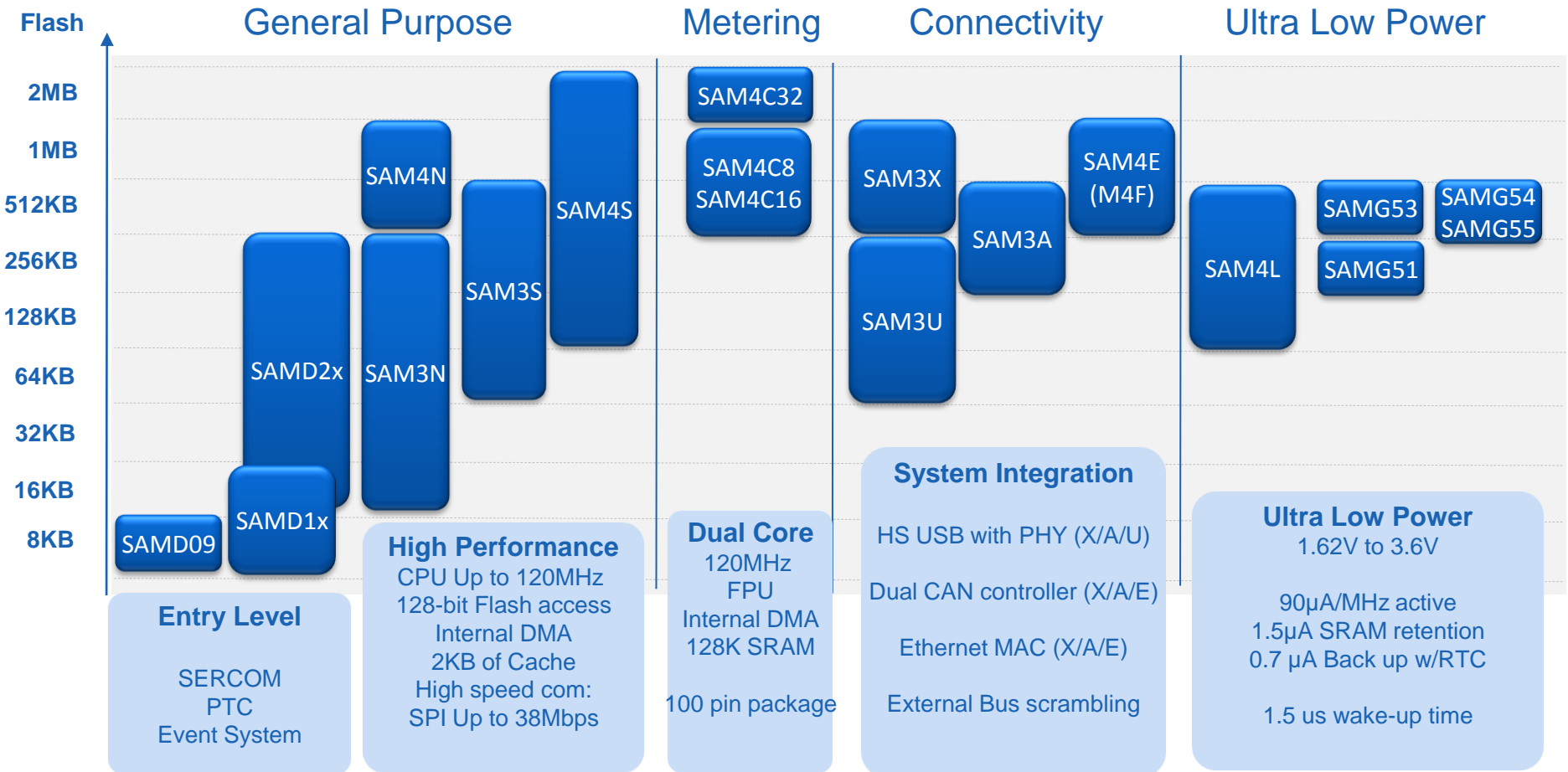

Introduction to Atmel SAM D family

Combining the best of Atmel MCUs with ARM Cortex-M0+

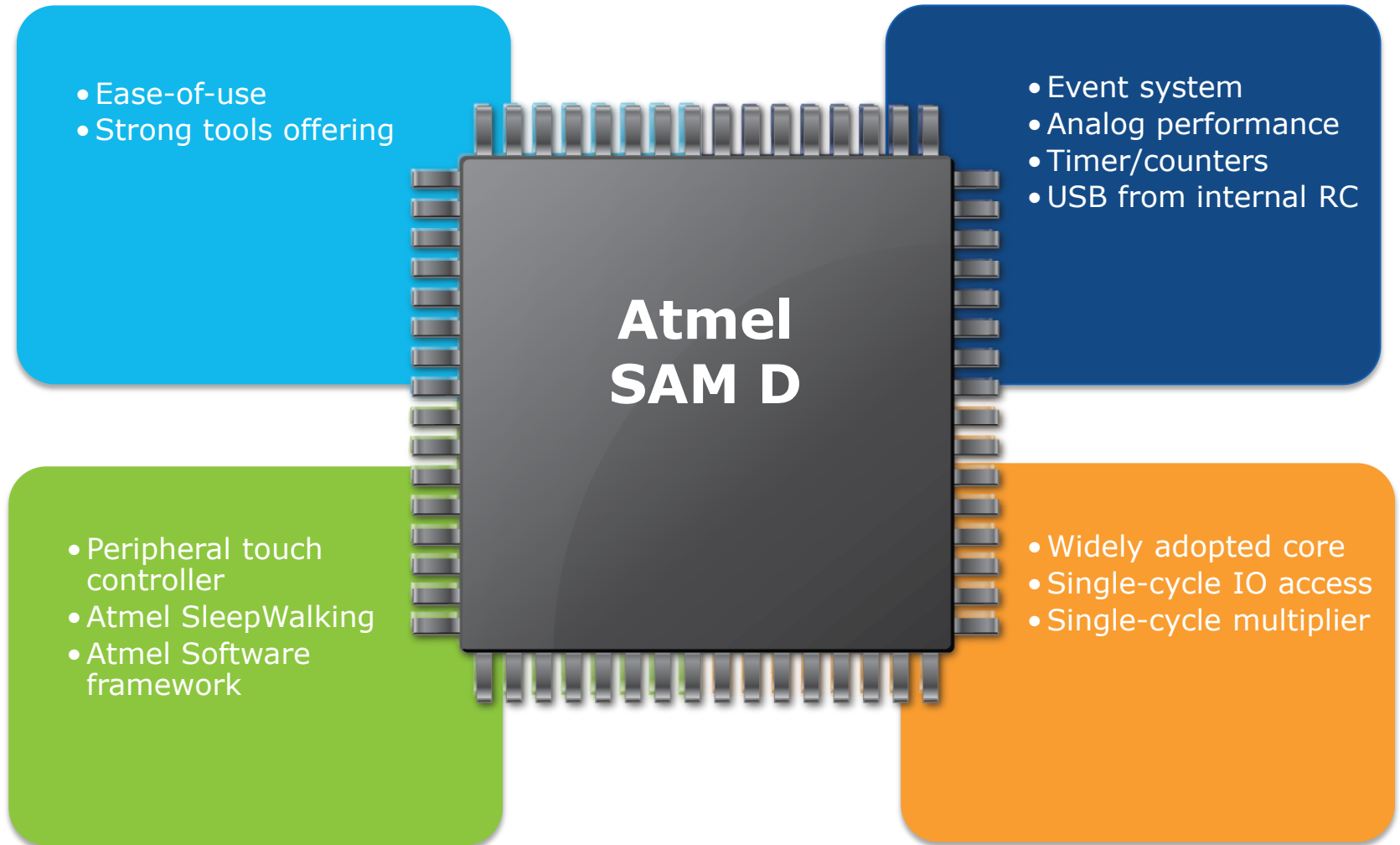

Introducing Atmel SAM D Family

Powerful and Efficient Products

- Atmel SAM D Product Family
 - 48MHz operation
 - Up to 2.14 CoreMark®
 - Down to 70µA/MHz
 - ±2% 8MHz int RC oscillator
 - 1.62V-3.63V
 - 4 product Series
 - 35 pin/memory/feature combinations
 - 8KB to 256KB Flash
 - 14-64 pin packages

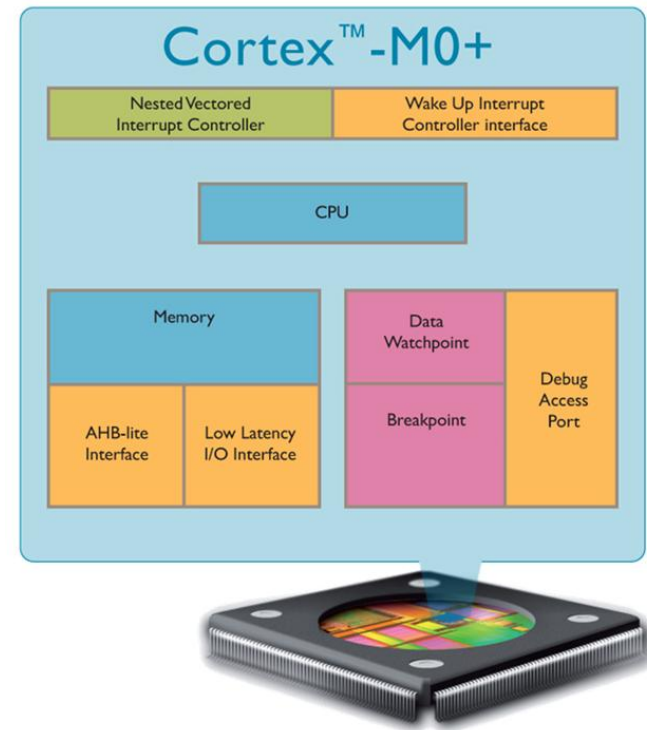

Atmel SAM D family

- Event system
- SERCOM modules configurable as I2C, USART or SPI
- Full Speed USB
 - Device from int RC oscillator
 - Embedded host
- Capacitive Touch HW engine
- 12-bit 350ksps ADC with gain stage
- 10-bit 350ksps DAC
- DMA Controller
- I2S
- Fractional PLL
- Timer/Counters

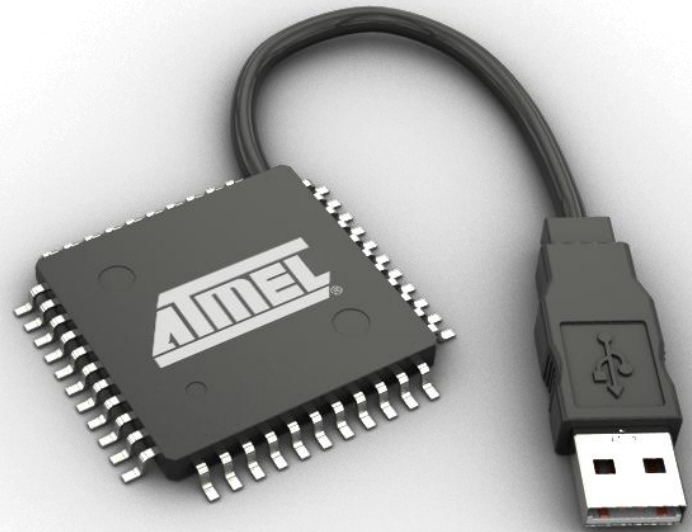

Peripheral Event System

Bringing the Innovation of Atmel AVR XMEGA to the Atmel SAM D Series

- Inter-peripheral Communication
 - CPU independent
 - Eight independent channels
 - Synchronous and Asynchronous
- Latency-free Event Handling
 - Safe fault protection
 - 100% predictable reaction time
- Advantages
 - Accurate timing
 - Efficiently offloading CPU
 - Reduced power consumption

Peripheral Events
GPIO
Timer /Counter
Asynchronous Timer (RTC)
Analog Comparator
ADC
DAC
Peripheral Touch Controller

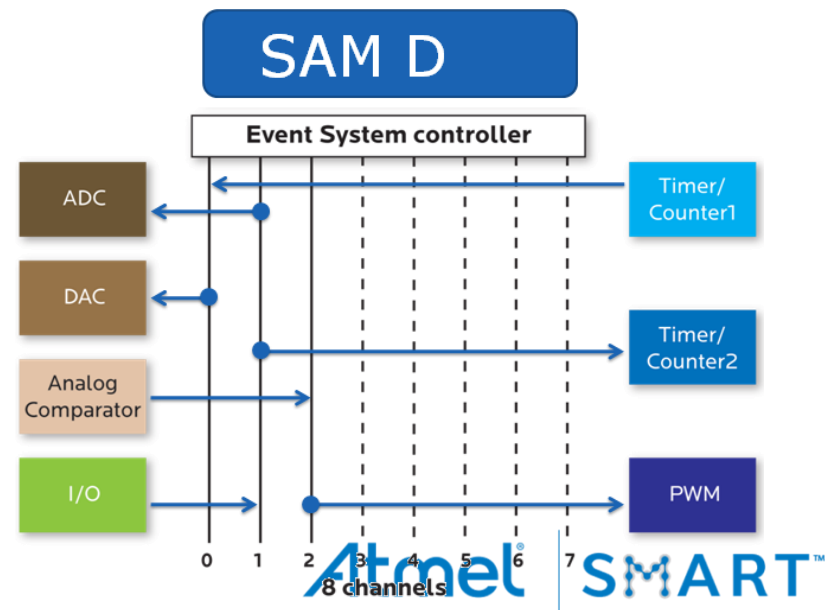

CPU

ADC

DAC

Analog
Comparator

I/O

Timer/
Counter

RTC

PWM

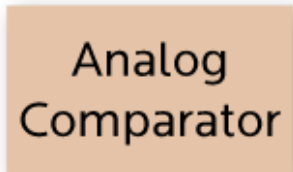
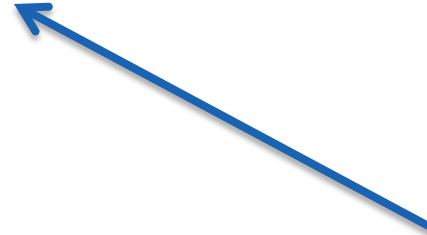

- Timer starts DAC conversion

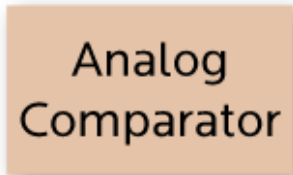

- Timer starts DAC conversion

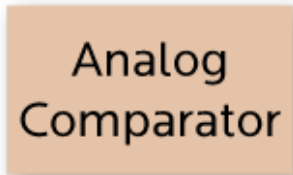

- Timer starts DAC conversion
- Analog Comparator stops PWM

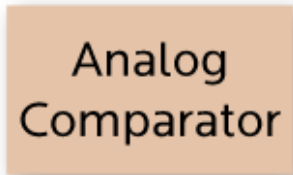

- Timer starts DAC conversion
- Analog Comparator stops PWM

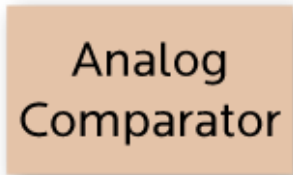

- Timer starts DAC conversion
- Analog Comparator stops PWM
- I/O starts ADC + time stamp

CPU

ADC

DAC

Analog
Comparator

I/O

Timer/
Counter

RTC

PWM

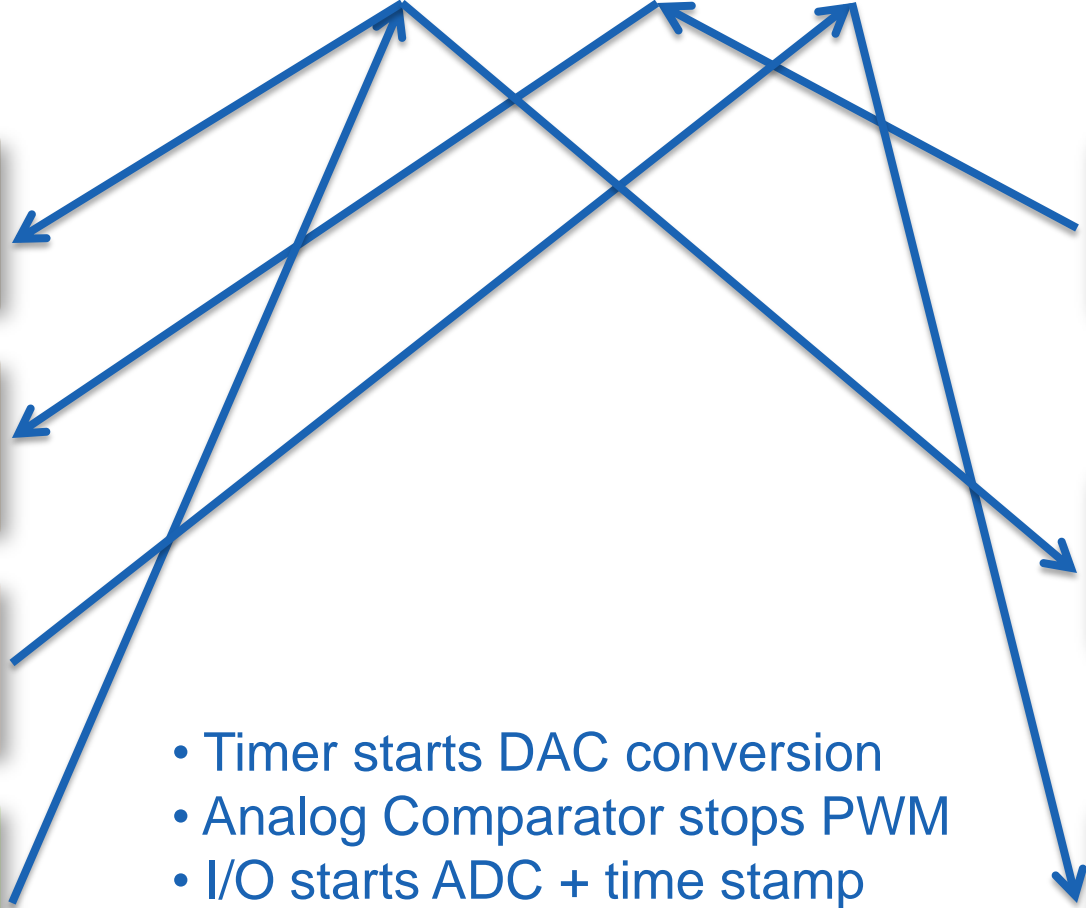

- Timer starts DAC conversion
- Analog Comparator stops PWM
- I/O starts ADC + time stamp
- ...

CPU

ADC

Timer/
Counter

DAC

Overload

RTC

Analog
Comparator

- Timer starts DAC conversion
- Analog Comparator stops PWM
- I/O starts ADC + time stamp
- ...

I/O

PWM

SAM D

Event System controller

ADC

Timer/
Counter

DAC

Solution

RTC

Analog
Comparator

I/O

PWM

0 1 2 3 4 5 6 7

8 channels

SAM D

Event System controller

ADC

DAC

Analog
Comparator

I/O

Timer/
Counter

RTC

PWM

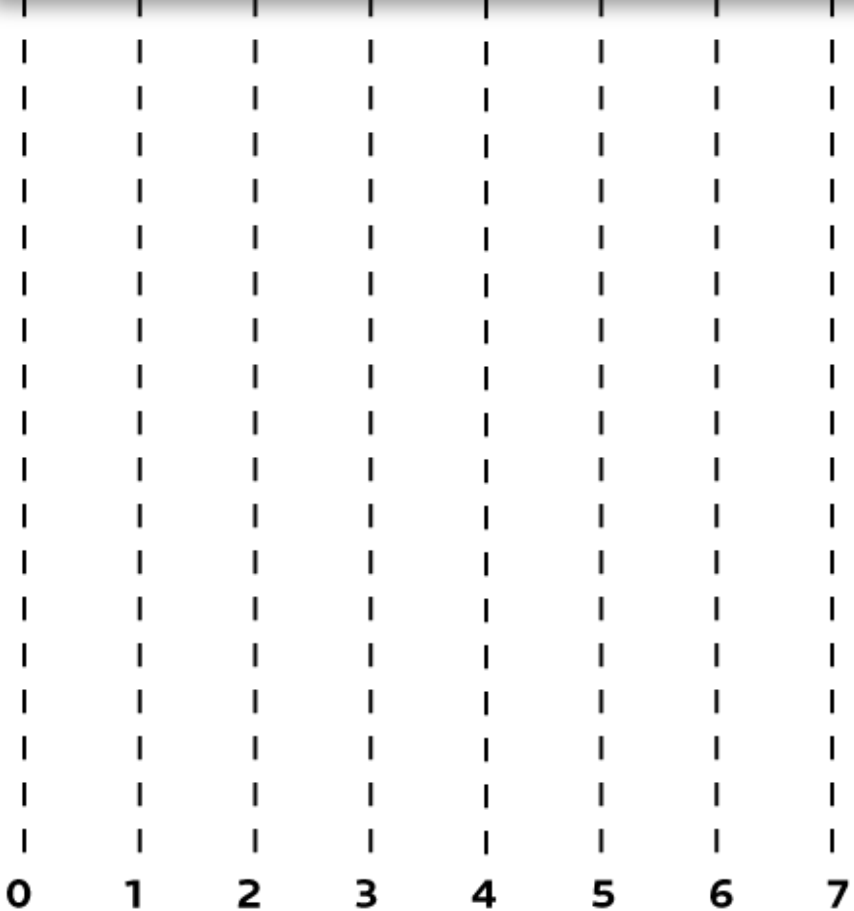

8 channels

SAM D

Event System controller

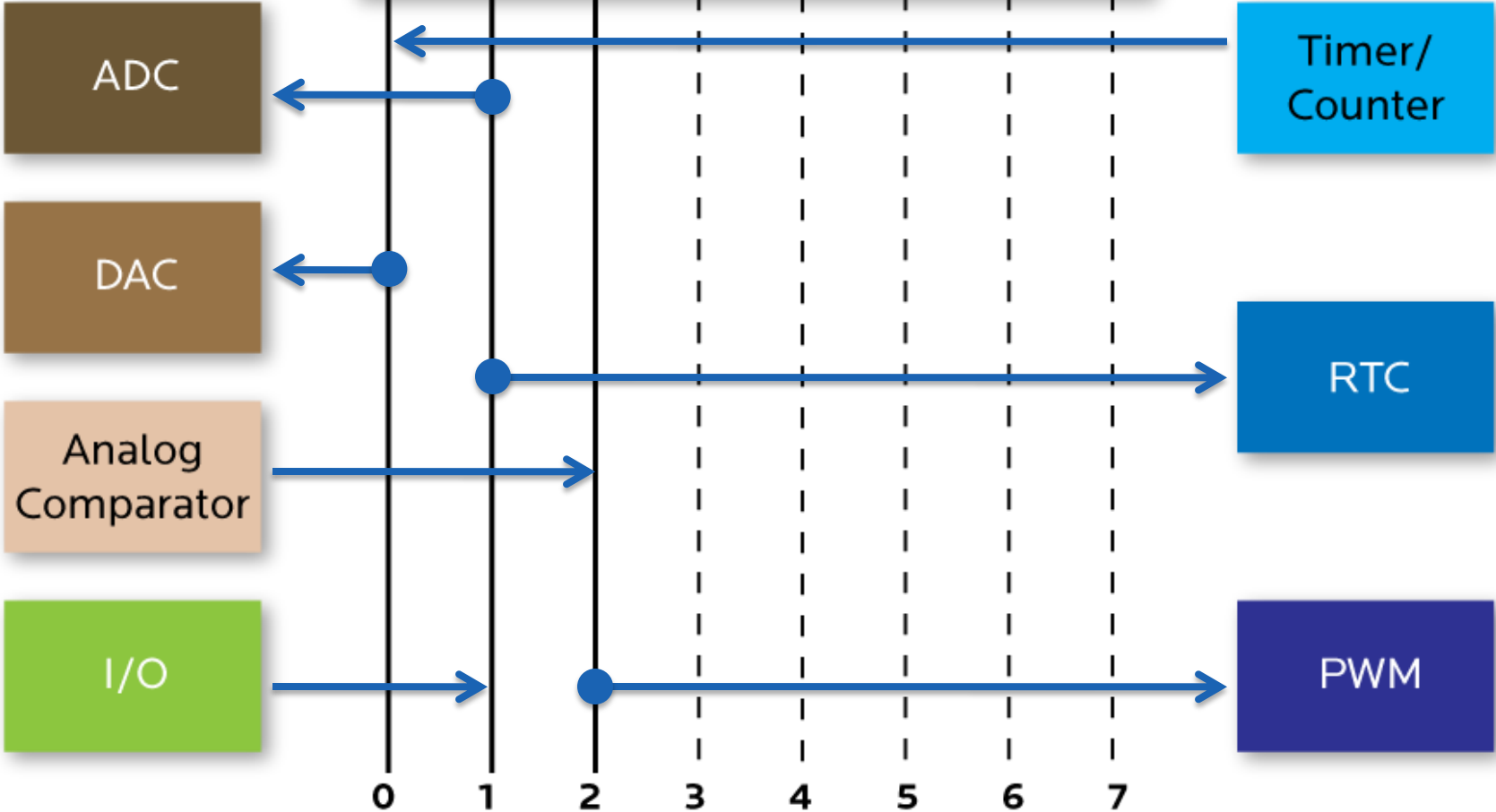

SAM D

Event System controller

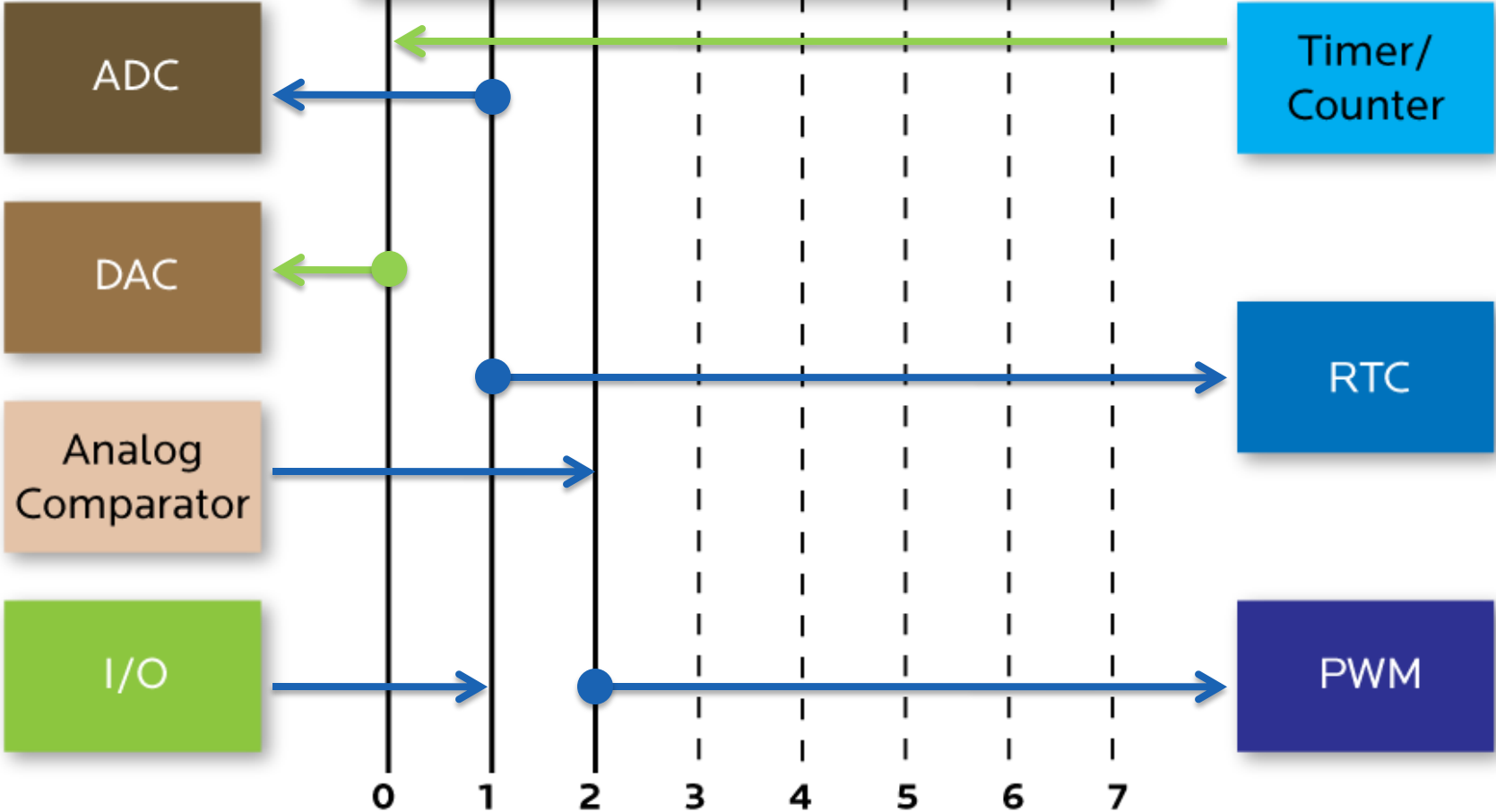

8 channels

SAM D

Event System controller

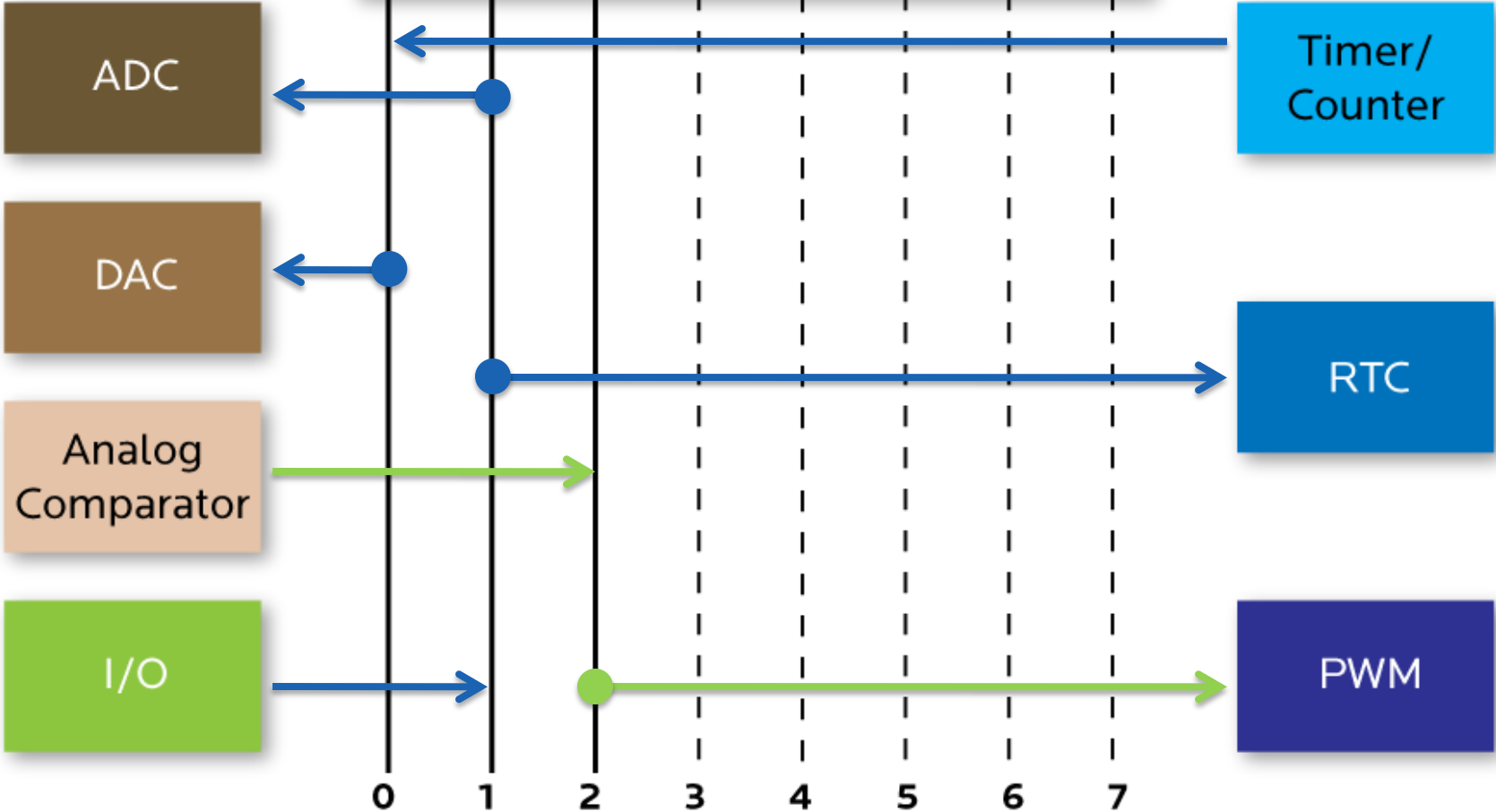

8 channels

SAM D

Event System controller

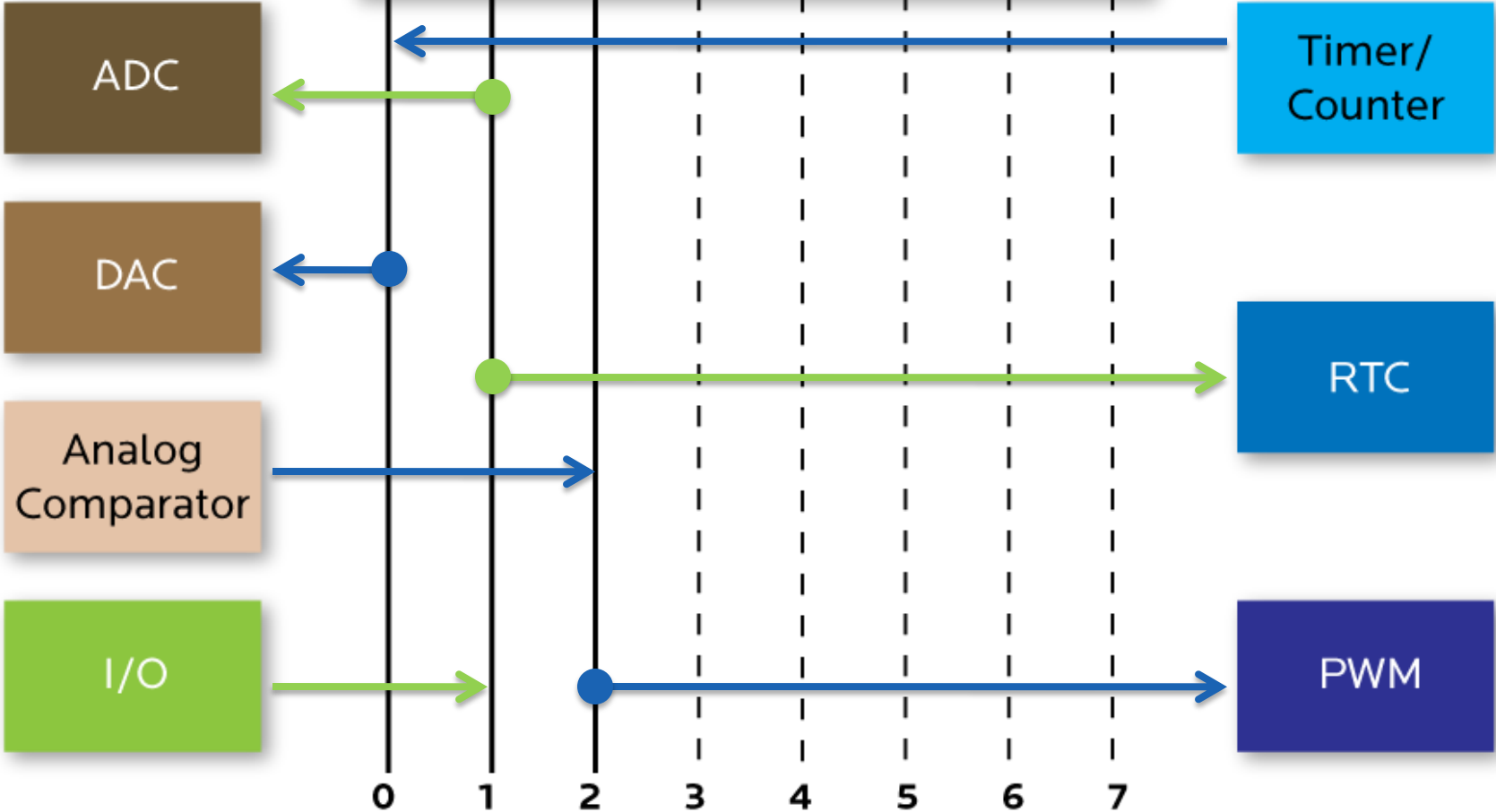

8 channels

SAM D

Event System controller

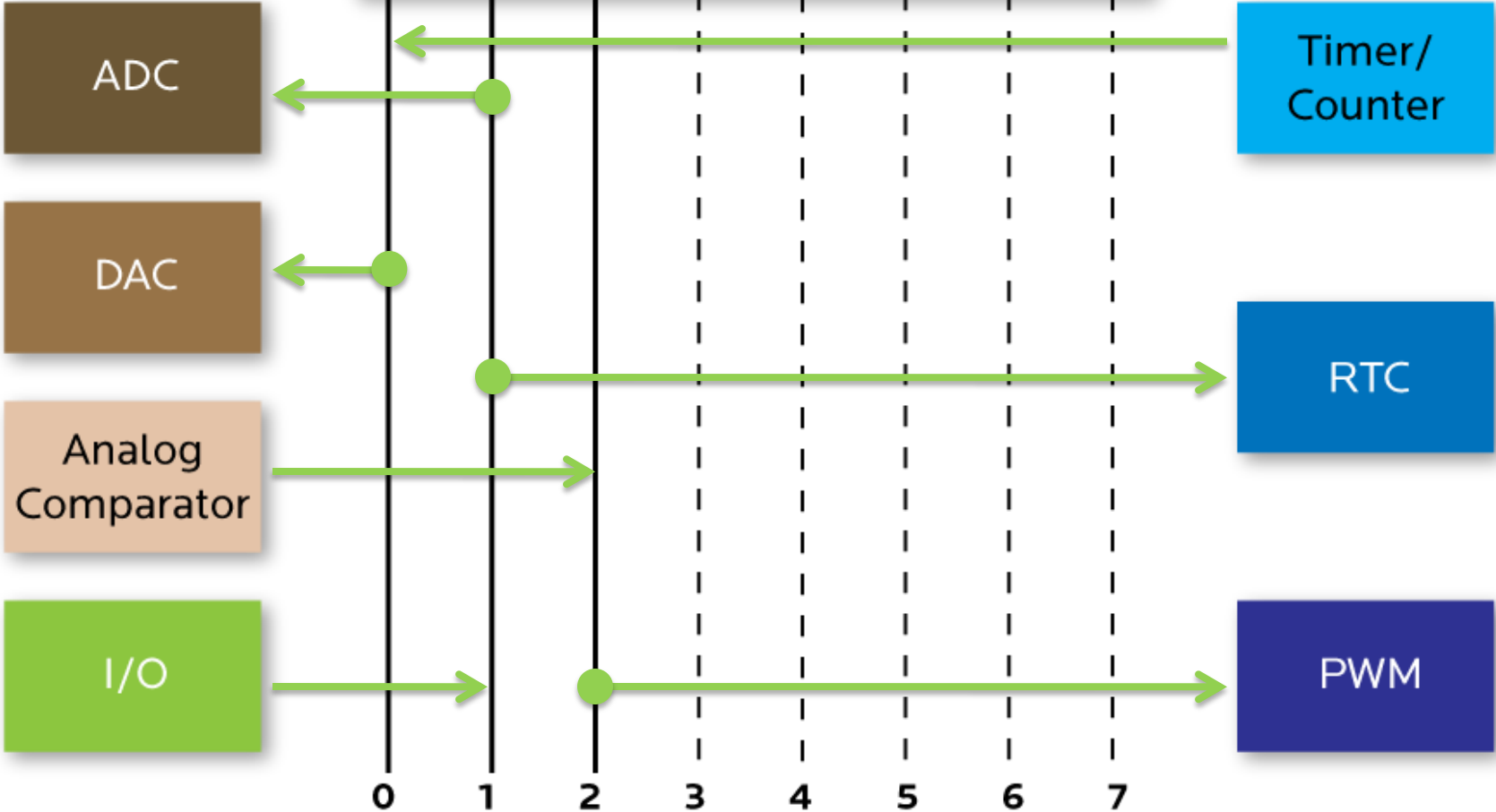

8 channels

Peripheral Event System

Bringing the Innovation of Atmel AVR XMEGA to the Atmel SAM D Series

- Inter-peripheral Communication
 - CPU independent
 - Eight independent channels
 - Synchronous and Asynchronous
- Latency-free Event Handling
 - Safe fault protection
 - 100% predictable reaction time
- Advantages
 - Accurate timing
 - Efficiently offloading CPU
 - Reduced power consumption

Peripheral Events
GPIO
Timer /Counter
Asynchronous Timer (RTC)
Analog Comparator
ADC
DAC
Peripheral Touch Controller

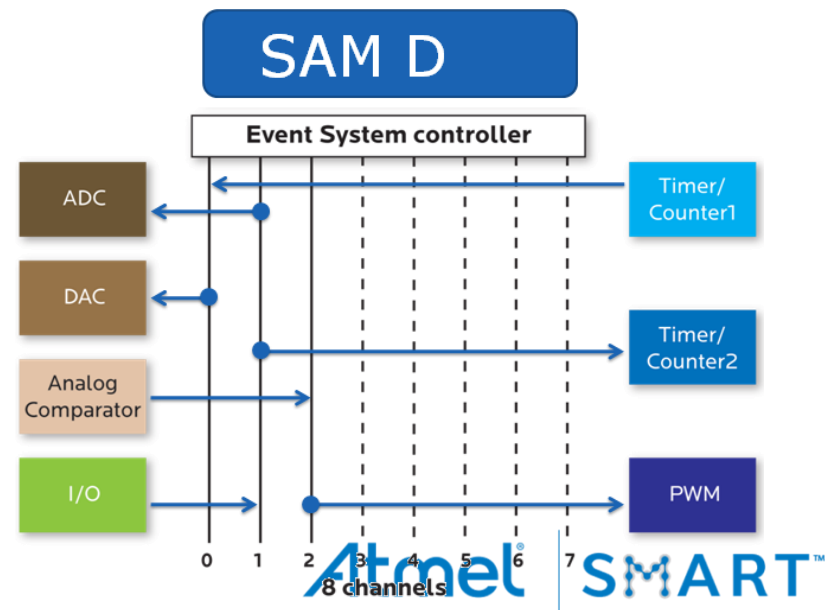

Serial Communication Module (SERCOM)

Highly Flexible Multi-interface Communication Module

- Configurable as
 - I2C
 - SPI
 - USART
- Supporting PM/SMBus & IrDA
- Double-buffered Reception
- IO Pin multiplexing
- Reconfigurable from software
- Wake-up from All Power Modes
 - I2C address match
 - SPI data reception
 - USART start detection

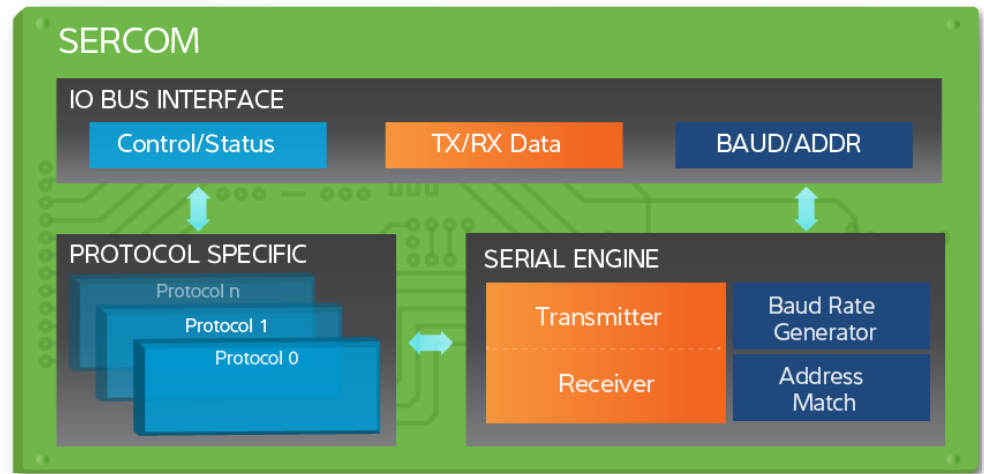

Peripheral Touch Controller (PTC)

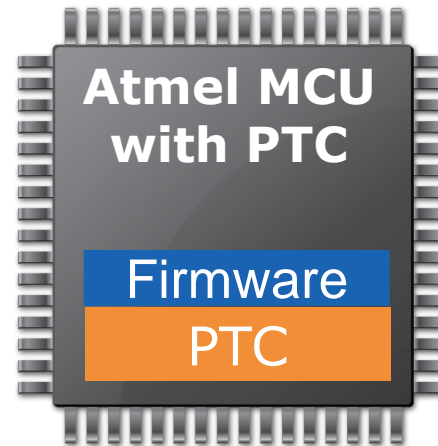
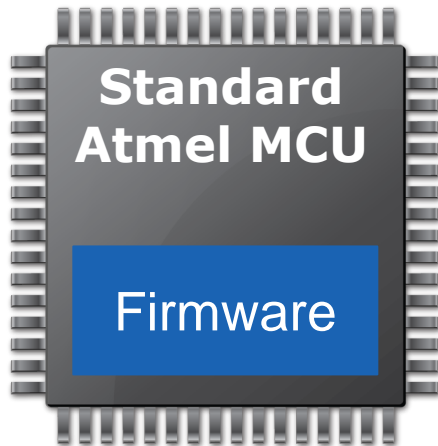

- All firmware solution
 - Constraints when used with timing critical application code
 - Requires tuning to work in noisy environments
- ✓ Dedicated hardware touch controller
 - ✓ Works great with any application code
 - ✓ Easily passes 10V conducted immunity tests

Peripheral Touch Controller (PTC)

- Supports Buttons, Sliders, and Wheels
- Supports Mutual- and Self-Capacitive Touch
 - Self-(re)calibrating, no tuning needed
 - No external components needed
- Excellent conducted immunity (CI)
 - Built-in hardware filtering
 - Passes 3V CI with no external components
 - Passes 10V CI with 100K series resistor
- Low standby power consumption
 - 6 μ A scanning one channel at 200ms scan rate
- Low CPU Utilization
 - 5% CPU utilization scanning 10 channels at 50ms scan rate

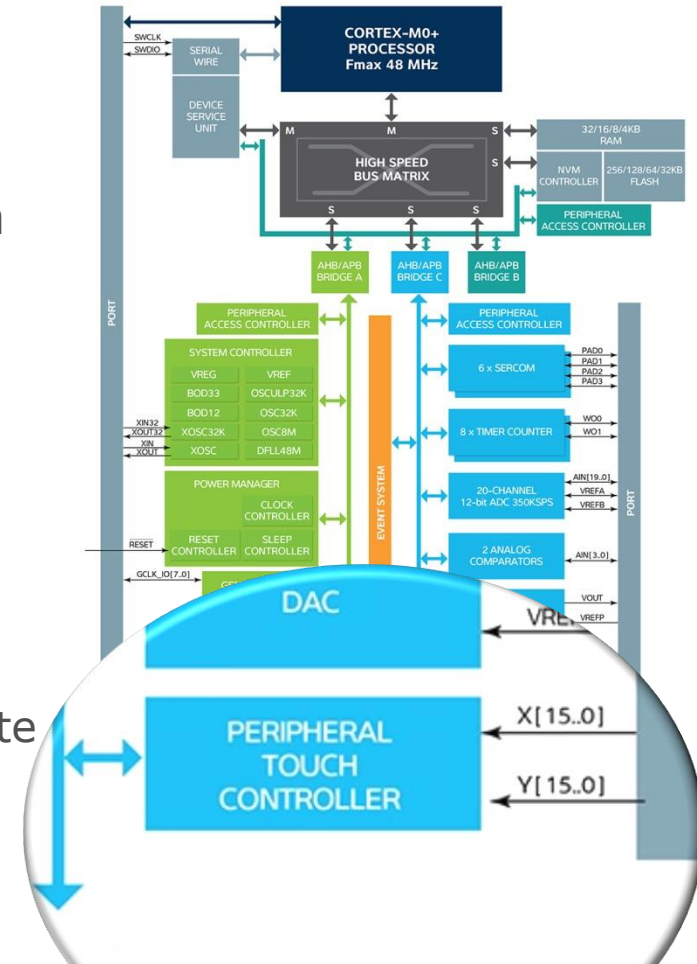

Peripheral Touch Controller (PTC)

High Channel Count

Package	PTC channels Mutual Cap	PTC channels Self Cap
64-pin	Up to 256	Up to 16
48-pin	Up to 120	Up to 10
32-pin	Up to 60	Up to 6
24-pin	Up to 72	Up to 16
20-pin	Up to 42	Up to 13
14-pin	Up to 12	Up to 7



New Features

Added to SAMD09/10/11/21

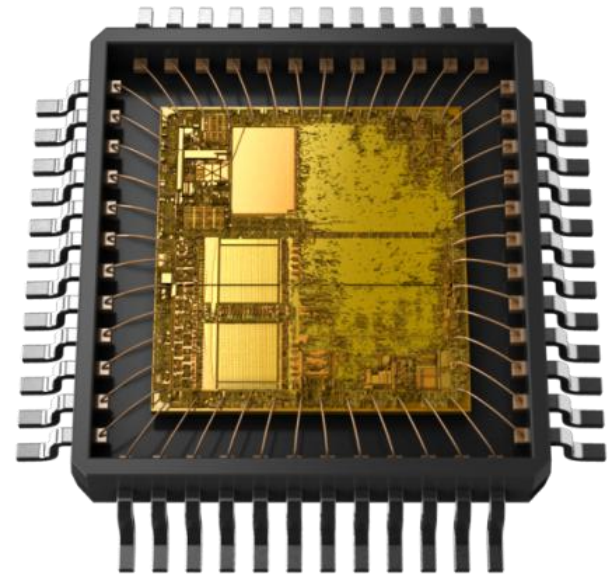

Direct Memory Access - DMA

Available in SAM D09, D10, D11 and D21

- Supports Data Transfers
 - Peripheral to Peripheral
 - Peripheral to Memory
 - Memory to Peripheral
 - Memory to Memory
- Transfer triggers
 - Software
 - Event System
 - Peripherals
- 12 Channels
 - Suspend/resume support for each channel
 - PingPong Operation with Event System
- 3 priority levels
- Flexible Addressing modes
 - Static
 - Programmable increment
- 1- 64KB data transfers
- Connected to
 - ADC,DAC,I2S,SERCOM,T/C,T/CC
- CRC support on transfers
 - CRC-16 (CRC-CCITT)
 - CRC-32 (IEEE 802.3)

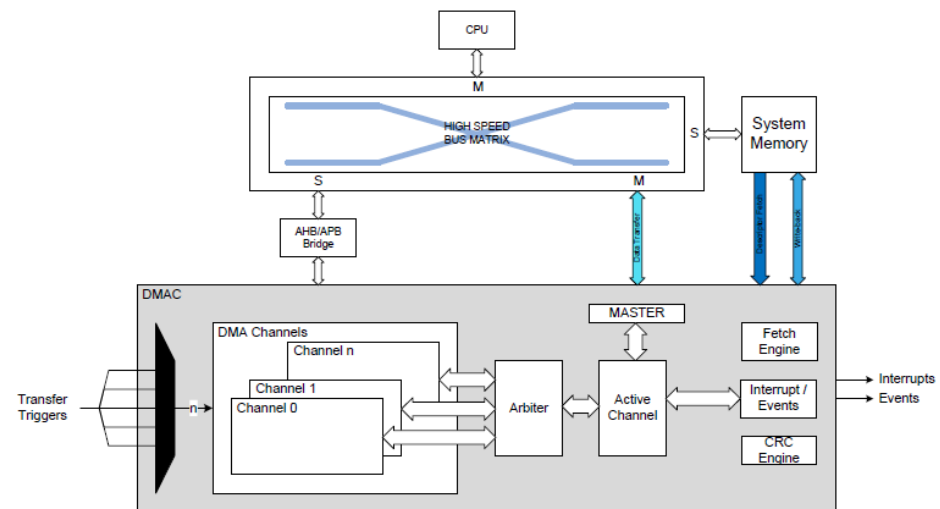

Full Speed USB

USB Device in SAM D11, USB Device and Host in D21

- Supports USB Full (12Mbit/s) and Low speed (1.5Mbit/s)
- No Need for external components
 - On-chip transceivers with built-in pull-ups and pull-downs
 - On-Chip USB serial resistors
 - USB Full Speed device operation from internal RC oscillator
- No endpoint/pipe size limitations
 - Uses Device SRAM as communication buffer
- Built-in DMA with multi-packet and double bank
- Supports feedback endpoint
- If USB is not needed, USB pins can be configured to GPIO



Inter IC Sound Controller - I2S with FPLL

Available in SAM D21

Bidirectional, synchronous, digital Audio link to external audio devices

- 2 independent Serializers configurable as receiver or transmitter
- 32-, 24-, 20-, 18-, 16-, and 8-bit mono or stereo format
- 16- and 8-bit compact stereo format
 - left and right samples packed in the same word to reduce data transfers
- Peripheral DMA channels, separate for each Serializer, allow a continuous high bit rate data transfer without processor intervention
 - Audio CODECs in Master, Slave, or Controller mode
 - Stereo DAC or ADC through dedicated I2S serial interface
 - Multi-slot or multiple stereo DACs or ADCs, using the TDM format
 - Mono or stereo MEMS microphones, using the PDM interface
- Fractional Digital Phase locked loop enables synchronization of data for USB to I2S streaming without audio glitches from a single crystal

Enhanced Timer/Counter Unit (TCC)

Perfect for SMPS, Lighting and Motor application fields

- Up to 96 MHz native resolution
- 4,5, 6 bit dithering resolution improvement (freq. & pulse width)
- 2 to 4 independent Output Comp/Input Capture channels per TCC
- Circular buffers for asymmetrical Push-pull control
- Advance capture features (for zero crossing detection).

Fault handling

- Connected to Timer/Counter output and WeX input
- Fast, synchronous and asynchronous fault triggering
- Flexible configuration with multiple fault sources
- Handle recoverable and non-recoverable fault modes

Waveform extension

- Output matrix support
- DTI unit
- SWAP function
- Pattern generator

Advantages

- Optimized functionality for advanced PWM and waveform output
- Full **autonomous** support of critical power switching applications

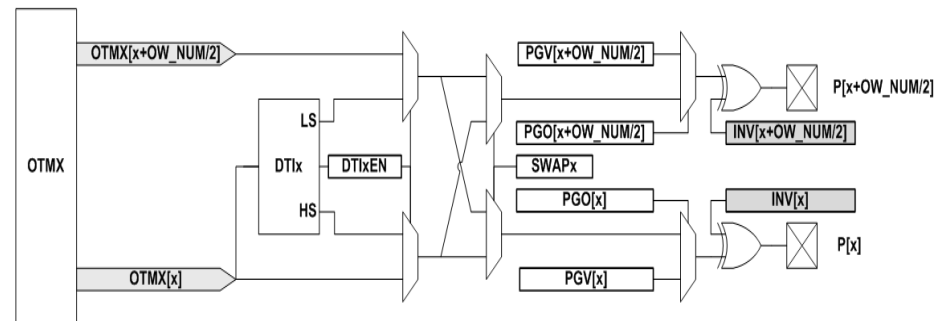

High GPIO pin count on small packages

Available in SAM D09, D10 and D11

- Only 2 pins used for Power and GND
 - Even when running USB Device!
- Reset can be used as GPIO
- Up to 22 GPIO on 24 pin QFN
- Up to 18 GPIO on 20 pin SOIC
- Up to 12 GPIO on 14 pin SOIC

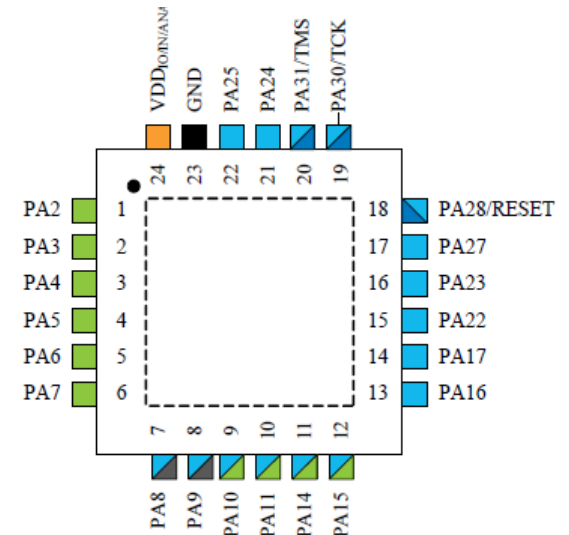
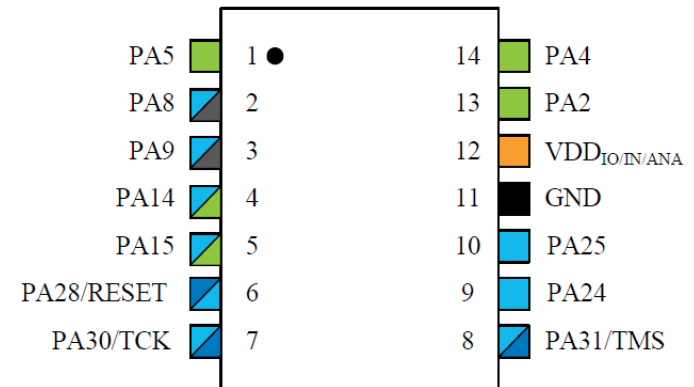

- For reference:
 - ST only has 15 GPIO on QFN20 (STM32F030) = less functionality
 - And need 5 external components = \$\$ + Board space

Other Improvements

Available in SAM D09, D10, D11 and D21

- SERCOM
 - I2C increased from 1MHz to 3.4MHz
 - Autobaud on UART
 - LIN support
 - SMBus/ PMBus support
 - IrDA support up to 115.2bkps
- CPU
 - Added Micro Trace Buffer

SAM D Atmel | SMART CM0+ Family Overview

SAM D Family Features	SAM D09	SAM D10	SAM D11	SAM D20	SAM D21
Cortex M0+	8KB Flash	8-16KB Flash		16-256KB Flash	32-256KB Flash
Event System					
SERCOM					
PTC(*)	14 pins	14, 20 and 24 pins		32, 48 and 64 pins	
12-bit 350 ksps ADC					
10-bit 350 ksps DAC*	6-ch DMA				12-ch DMA
2xAnalog Comparator*					
32-bit RTC w/Calendar	1x T/C for Control				3x T/C for Control
Serial Wire Debug					
BOR and POR					
Internal RCs			FS USB Device		FS USB H&D
Watchdog					
High GPIO Count					I ² S

* = not on D09

Atmel SAM D summary

- SAM D Combining the best of Atmel AVR® MCUs with ARM CM0+
 - Peripheral intelligence
 - Event system and DMA
 - SERCOM
 - Full Speed USB embedded Host and Device
 - Peripheral Touch Controller
 - Large GPIO count
 - Short design time
-
- Everything is compatible!

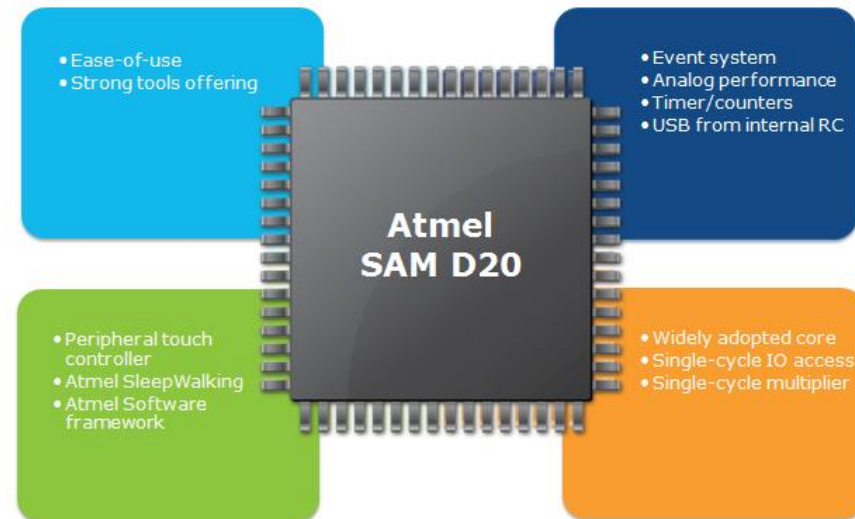



Enabling Unlimited Possibilities®

© 2012 Atmel Corporation. All rights reserved.

Atmel®, Atmel logo and combinations thereof, Enabling Unlimited Possibilities®, and others are registered trademarks or trademarks of Atmel Corporation or its subsidiaries. Other terms and product names may be trademarks of others.

Disclaimer: The information in this document is provided in connection with Atmel products. No license, express or implied, by estoppel or otherwise, to any intellectual property right is granted by this document or in connection with the sale of Atmel products. EXCEPT AS SET FORTH IN THE ATMEL TERMS AND CONDITIONS OF SALES LOCATED ON THE ATMEL WEBSITE, ATMEL ASSUMES NO LIABILITY WHATSOEVER AND DISCLAIMS ANY EXPRESS, IMPLIED OR STATUTORY WARRANTY RELATING TO ITS PRODUCTS INCLUDING, BUT NOT LIMITED TO, THE IMPLIED WARRANTY OF MERCHANTABILITY, FITNESS FOR A PARTICULAR PURPOSE, OR NON-INFRINGEMENT. IN NO EVENT SHALL ATMEL BE LIABLE FOR ANY DIRECT, INDIRECT, CONSEQUENTIAL, PUNITIVE, SPECIAL OR INCIDENTAL DAMAGES (INCLUDING, WITHOUT LIMITATION, DAMAGES FOR LOSS AND PROFITS, BUSINESS INTERRUPTION, OR LOSS OF INFORMATION) ARISING OUT OF THE USE OR INABILITY TO USE THIS DOCUMENT, EVEN IF ATMEL HAS BEEN ADVISED OF THE POSSIBILITY OF SUCH DAMAGES. Atmel makes no representations or warranties with respect to the accuracy or completeness of the contents of this document and reserves the right to make changes to specifications and products descriptions at any time without notice. Atmel does not make any commitment to update the information contained herein. Unless specifically provided otherwise, Atmel products are not suitable for, and shall not be used in, automotive applications. Atmel products are not intended, authorized, or warranted for use as components in applications intended to support or sustain life.