

SMT Air Coil Inductor

AIAC-2712C

RoHS
Compliant

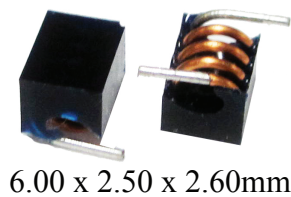

6.00 x 2.50 x 2.60mm

FEATURES:

- High current design
- Wide Range Frequency Response
- Excellent Q & SRF
- Standard flat cap top suitable for automatic placement.

APPLICATIONS:

- Widely used in Cordless Phones, High Frequency Communication Equipments, Intercom, CATV
- Noise reduction in voltage supply/bias for RF power transistors
- Broadband I/O filtering, frequency selection
- Impedance Matching
- Improves switch isolation for RF circuit

STANDARD SPECIFICATIONS:

PARAMETERS	
ABRACON P/N:	AIAC-2712C
Operating temperature:	-40 °C ~ +125 °C
Storage temperature:	-25°C to + 60°C

Part Number	Inductance	Tolerance	DCR (Max)	Q(Min)	SRF(Min)	Rated Current (Max)	Inductance Code
Units	nH	%	mΩ		GHz	A	
Symbol	L	J	DCR			IDC	
AIAC-2712C-17N5	17.50	J	4.5	100.0	2.2	3.5	17N5J
AIAC-2712C-22N0	22.00	J	5.0	100.0	2.0	3.0	22N0J
AIAC-2712C-28N0	28.00	J	5.6	100.0	1.8	2.8	28N0J
AIAC-2712C-35N5	35.50	J	6.2	100.0	1.2	2.7	35N5J
AIAC-2712C-43N5	43.50	J	6.7	100.0	1.0	2.5	43N5J

Test Conditions and equipments

Test frequency: 150MHz

Equipment: HP4191A

PART IDENTIFICATION:

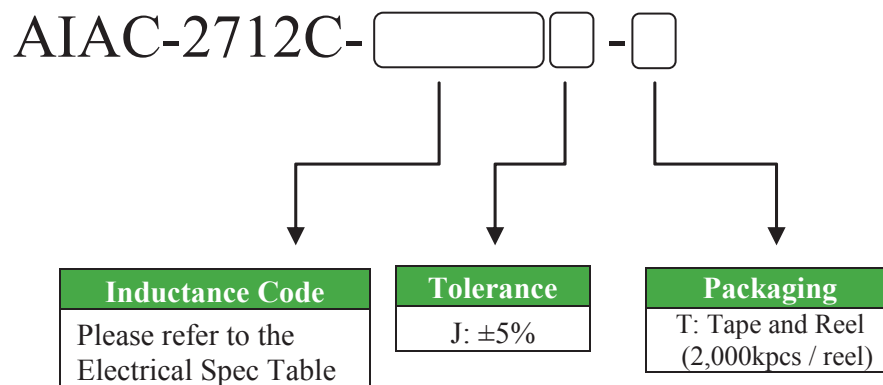

SMT Air Coil Inductor

AIAC-2712C

RoHS
Compliant

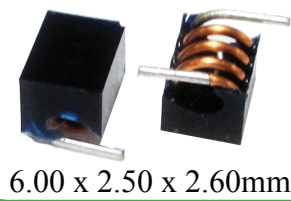

6.00 x 2.50 x 2.60mm

OUTLINE DRAWING:

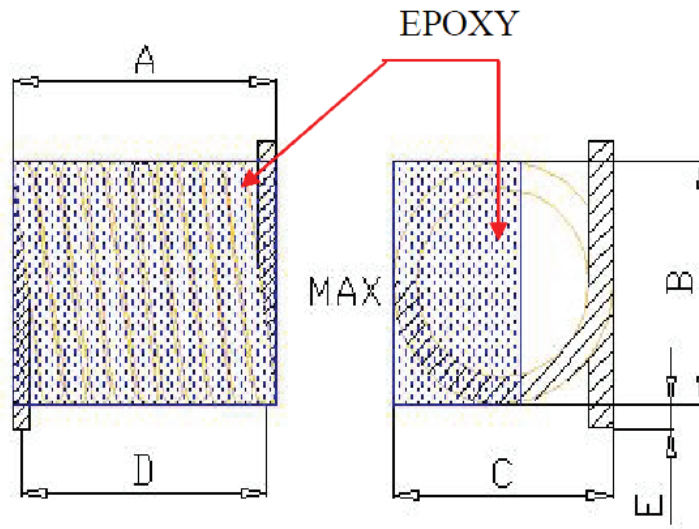

A	B	C	D	E
6.00±0.3	2.50±0.2	2.60±0.2	5.80±0.3	0.70±0.2

Schematic

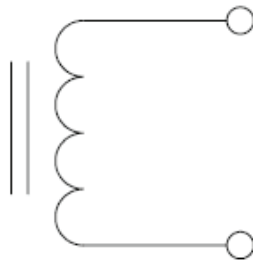

Recommended Land Pattern

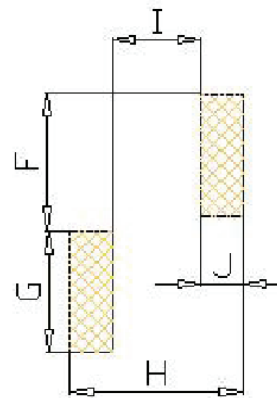

F	G	H	I	J
2.8	3.3	7.4	4.9	1.3

Dimension: mm

SMT Air Coil Inductor

AIAC-2712C

RoHS
Compliant

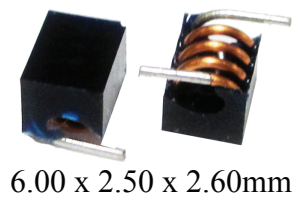

6.00 x 2.50 x 2.60mm

REFLOW PROFILE:

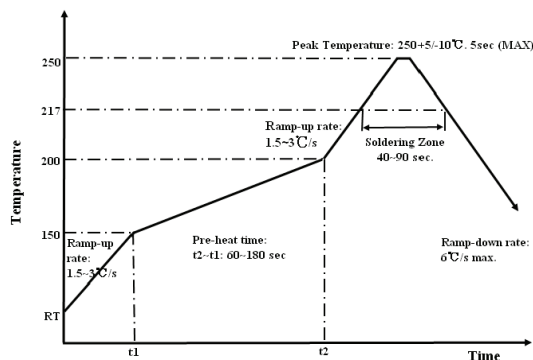

TAPE & REEL:

Packing
T: 2,000pcs / reel

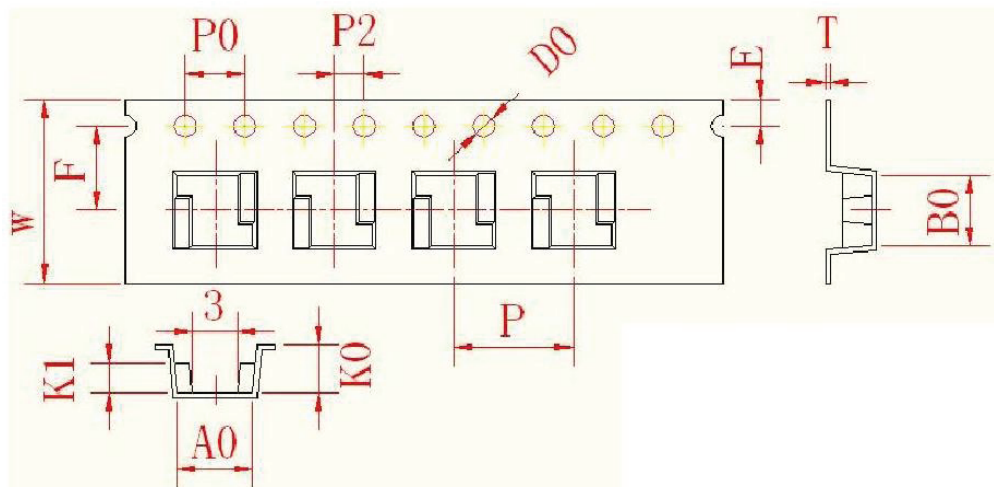

W	A0	B0	K0	K1	P	F	E	D0	P0	P2	T
16.0±0.3	4.7±0.1	6.8±0.1	3.2±0.1	2.0±0.1	8.0±0.1	7.5±0.1	1.75±0.1	1.5+0.1/-0	4.0±0.1	2.0±0.1	0.35±0.05

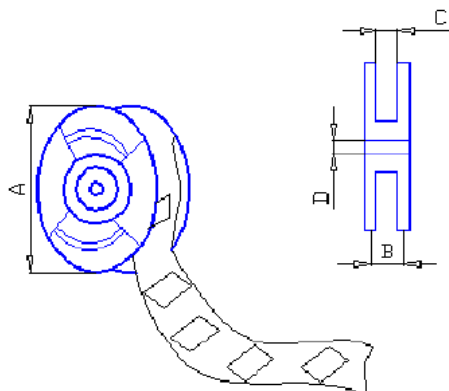

A	330
B	22
C	16
D	13

Dimension: mm

ATTENTION: Abracon Corporation's products are COTS – Commercial-Off-The-Shelf products; suitable for Commercial, Industrial and, where designated, Automotive Applications. Abracon's products are not specifically designed for Military, Aviation, Aerospace, Life-dependant Medical applications or any application requiring high reliability where component failure could result in loss of life and/or property. For applications requiring high reliability and/or presenting an extreme operating environment, written consent and authorization from Abracon Corporation is required. Please contact Abracon Corporation for more information.

ABRACON IS
ISO 9001:2008
CERTIFIED



Visit www.abracon.com for Terms & Conditions of Sale
30332 Esperanza, Rancho Santa Margarita, California 92688
tel 949-546-8000 | fax 949-546-8001 | www.abracon.com

Revised: 11.20.12