

74ACT899

9-Bit Latchable Transceiver with Parity Generator/Checker

General Description

The ACT899 is a 9-bit to 9-bit parity transceiver with transparent latches. The device can operate as a feed-through transceiver or it can generate/check parity from the 8-bit data busses in either direction. The ACT899 features independent latch enables for the A-to-B direction and the B-to-A direction, a select pin for ODD/EVEN parity, and separate error signal output pins for checking parity.

Features

- Latchable transceiver with output sink of 24 mA
- Option to select generate parity and check or "feed-through" data/parity in directions A-to-B or B-to-A
- Independent latch enable for A-to-B and B-to-A directions
- Select pin for ODD/EVEN parity
- \overline{ERRA} and \overline{ERRB} output pins for parity checking
- Ability to simultaneously generate and check parity
- May be used in system applications in place of the 657 and 373 (no need to change T/R to check parity)

Ordering Code:

Order Number	Package Number	Package Description
74ACT899QC	V28A	28-Lead Plastic Lead Chip Carrier (PLCC), JEDEC MO-047, 0.450" Square

Device also available in Tape and Reel. Specify by appending suffix letter "X" to the ordering code.

Logic Symbol

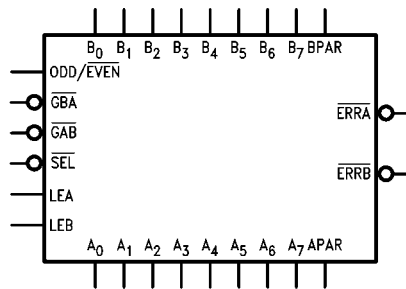

Connection Diagram

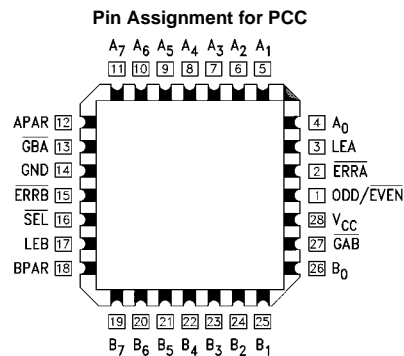

FACT™ is a trademark of Fairchild Semiconductor Corporation.

Pin Descriptions

Pin Names	Description
A ₀ -A ₇	A Bus Data Inputs/Data Outputs
B ₀ -B ₇	B Bus Data Inputs/Data Outputs
APAR, BPAR	A and B Bus Parity Inputs
ODD/ $\overline{\text{EVEN}}$	ODD/ $\overline{\text{EVEN}}$ Parity Select, Active LOW for EVEN Parity
$\overline{\text{GBA}}$, $\overline{\text{GAB}}$	Output Enables for A or B Bus, Active LOW
$\overline{\text{SEL}}$	Select Pin for Feed-Through or Generate Mode, LOW for Generate Mode
LEA, LEB	Latch Enables for A and B Latches, HIGH for Transparent Mode
$\overline{\text{ERRA}}$, $\overline{\text{ERRB}}$	Error Signals for Checking Generated Parity with Parity In, LOW if Error Occurs

Functional Description

The ACT899 has three principal modes of operation which are outlined below. These modes apply to both the A-to-B and B-to-A directions.

- Bus A (B) communicates to Bus B (A), parity is generated and passed on to the B (A) Bus as BPAR (APAR). If LEB (LEA) is HIGH and the Mode Select ($\overline{\text{SEL}}$) is LOW, the parity generated from B[0:7] (A[0:7]) can be checked and monitored by $\overline{\text{ERRB}}$ ($\overline{\text{ERRA}}$).
- Bus A (B) communicates to Bus B (A) in a feed-through mode if $\overline{\text{SEL}}$ is HIGH. Parity is still generated and checked as $\overline{\text{ERRA}}$ and $\overline{\text{ERRB}}$ in the feed-through mode (can be used as an interrupt to signal a data/parity bit error to the CPU).
- Independent Latch Enables (LEA and LEB) allow other permutations of generating/checking (see Function Table).

Function Table

Inputs					Operation
$\overline{\text{GAB}}$	$\overline{\text{GBA}}$	$\overline{\text{SEL}}$	LEA	LEB	
H	H	X	X	X	Busses A and B are 3-STATE.
H	L	L	L	H	Generates parity from B[0:7] based on O/ $\overline{\text{E}}$ (Note 1). Generated parity → APAR. Generated parity checked against BPAR and output as $\overline{\text{ERRB}}$.
H	L	L	H	H	Generates parity from B[0:7] based on O/ $\overline{\text{E}}$. Generated parity → APAR. Generated parity checked against BPAR and output as $\overline{\text{ERRB}}$. Generated parity also fed back through the A latch for generate/check as $\overline{\text{ERRA}}$.
H	L	L	X	L	Generates parity from B latch data based on O/ $\overline{\text{E}}$. Generated parity → APAR. Generated parity checked against latched BPAR and output as $\overline{\text{ERRB}}$.
H	L	H	X	H	BPAR/B[0:7] → APAR/A[0:7] Feed-through mode. Generated parity checked against BPAR and output as $\overline{\text{ERRB}}$.
H	L	H	H	H	BPAR/B[0:7] → APAR/A[0:7] Feed-through mode. Generated parity checked against BPAR and output as $\overline{\text{ERRB}}$. Generated parity also fed back through the A latch for generate/check as $\overline{\text{ERRA}}$.
L	H	L	H	L	Generates parity for A[0:7] based on O/ $\overline{\text{E}}$. Generated parity → BPAR. Generated parity checked against APAR and output as $\overline{\text{ERRA}}$.
L	H	L	H	H	Generates parity from A[0:7] based on O/ $\overline{\text{E}}$. Generated parity → BPAR. Generated parity checked against APAR and output as $\overline{\text{ERRA}}$. Generated parity also fed back through the B latch for generate/check as $\overline{\text{ERRB}}$.
L	H	L	L	X	Generates parity from A latch data based on O/ $\overline{\text{E}}$. Generated parity → BPAR. Generated parity checked against latched APAR and output as $\overline{\text{ERRA}}$.
L	H	H	H	L	APAR/A[0:7] → BPAR/B[0:7] Feed-through mode. Generated parity checked against APAR and output as $\overline{\text{ERRA}}$.
L	H	H	H	H	APAR/A[0:7] → BPAR/B[0:7] Feed-through mode. Generated parity checked against APAR and output as $\overline{\text{ERRA}}$. Generated parity also fed back through the B latch for generate/check as $\overline{\text{ERRB}}$.

H = HIGH Voltage Level
L = LOW Voltage Level
X = Immaterial

Note 1: O/ $\overline{\text{E}}$ = ODD/ $\overline{\text{EVEN}}$

Functional Block Diagram

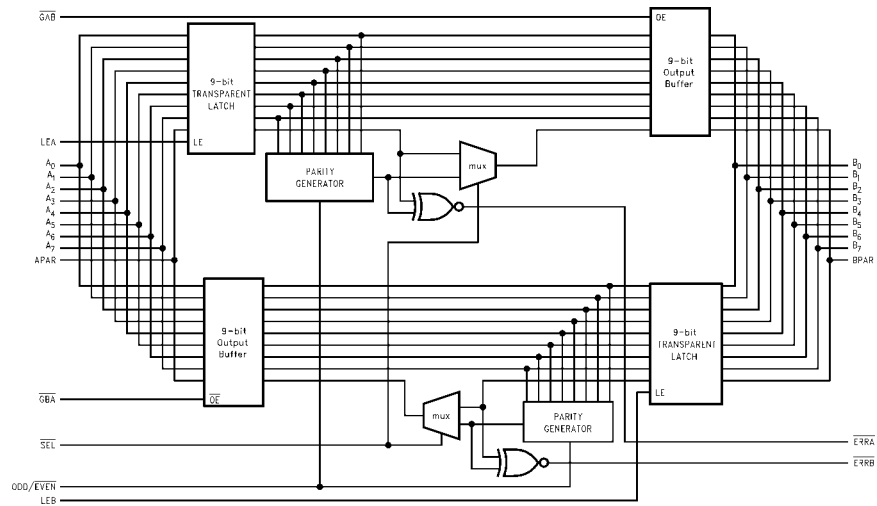

AC Path

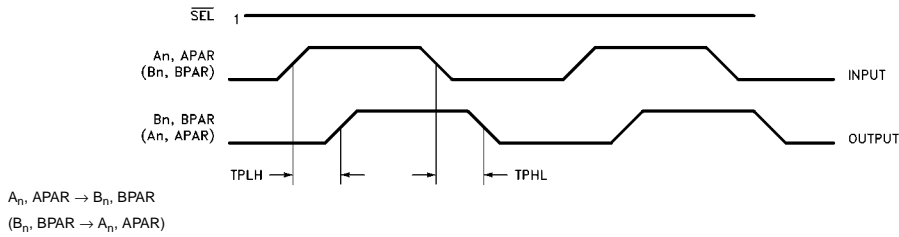

FIGURE 1.

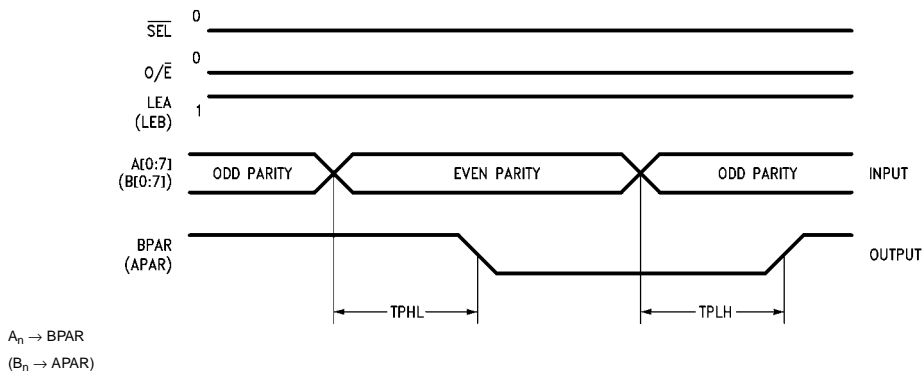

FIGURE 2.

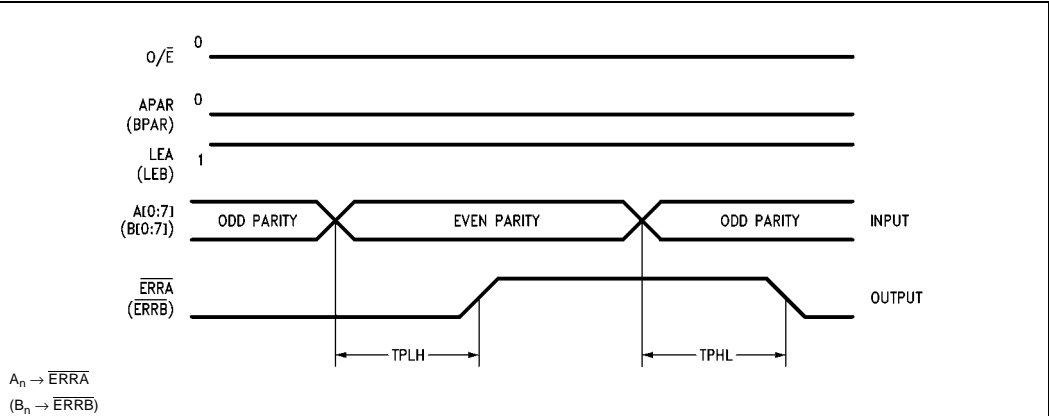

FIGURE 3.

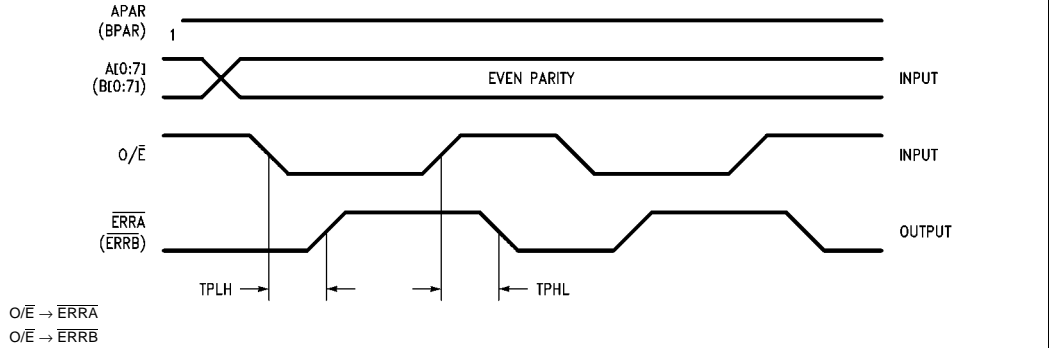

FIGURE 4.

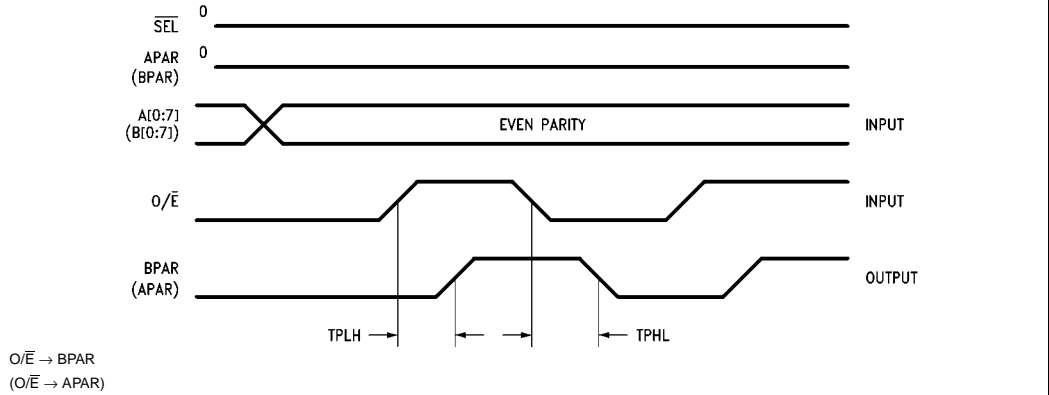
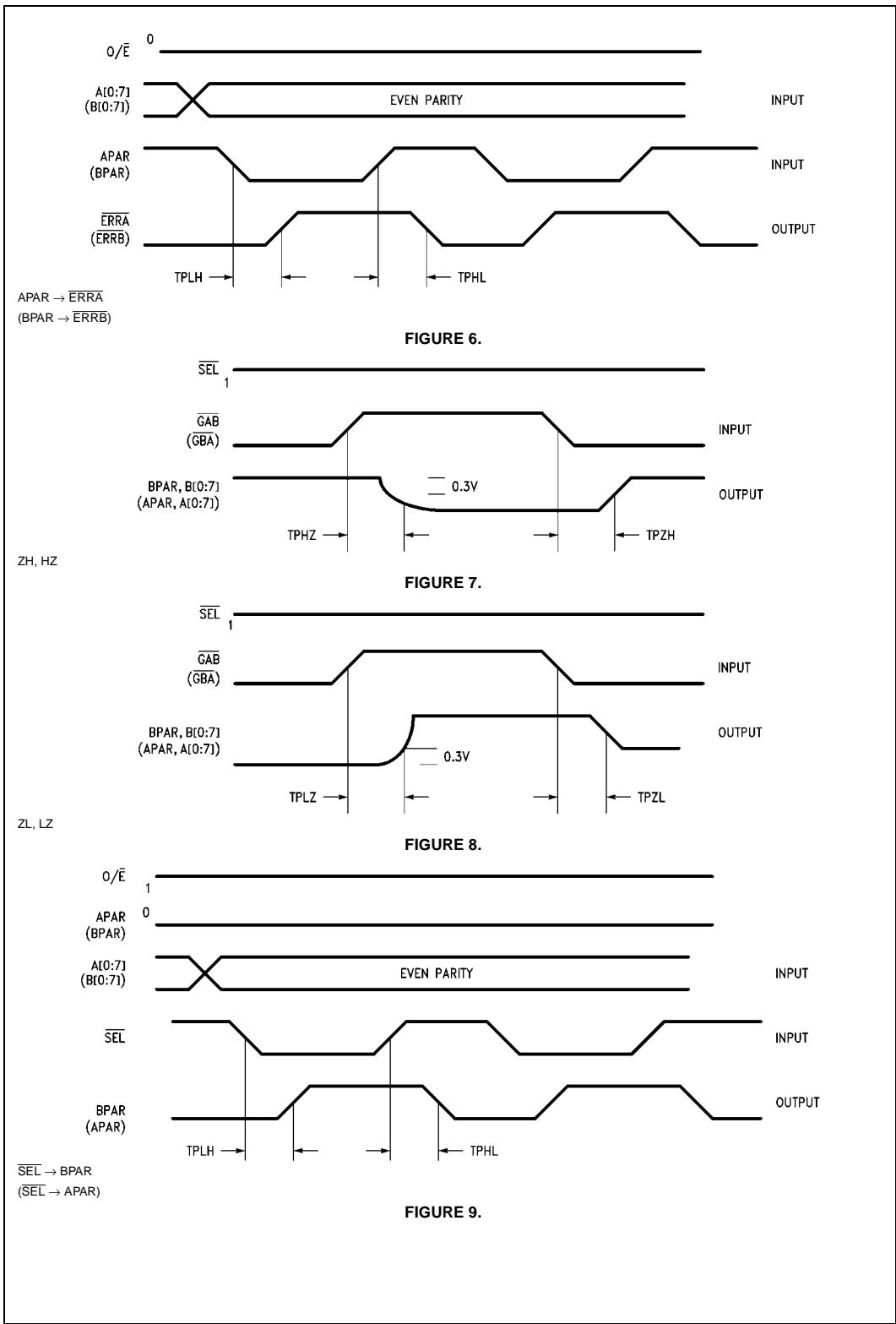

FIGURE 5.



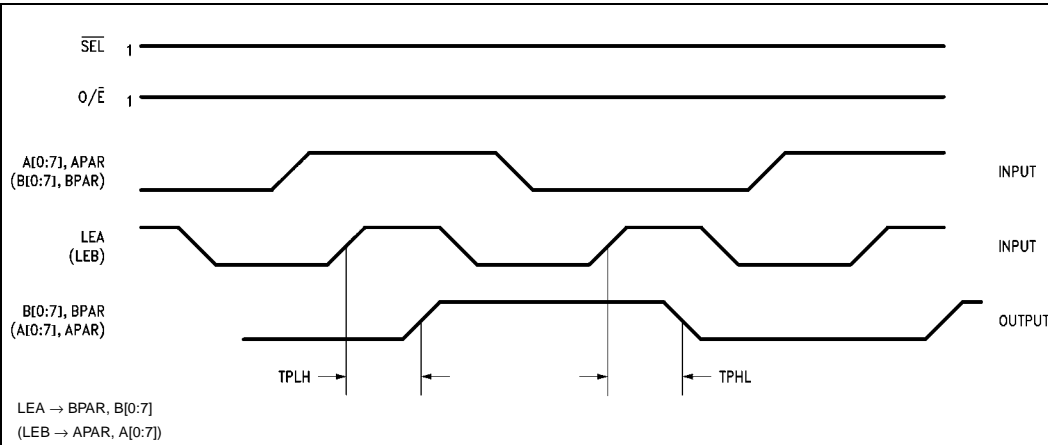

FIGURE 10.

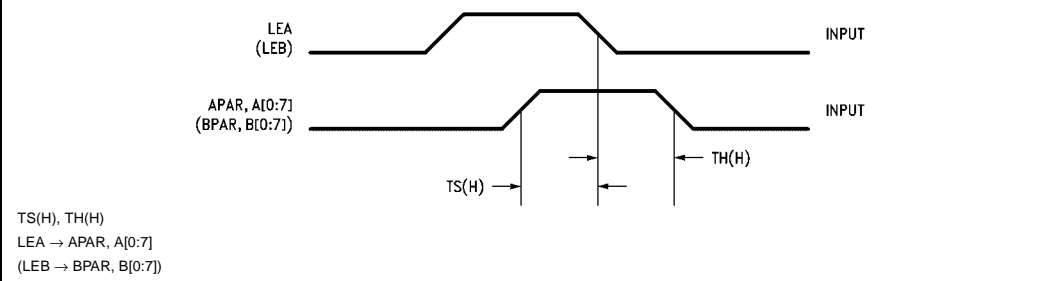

FIGURE 11.

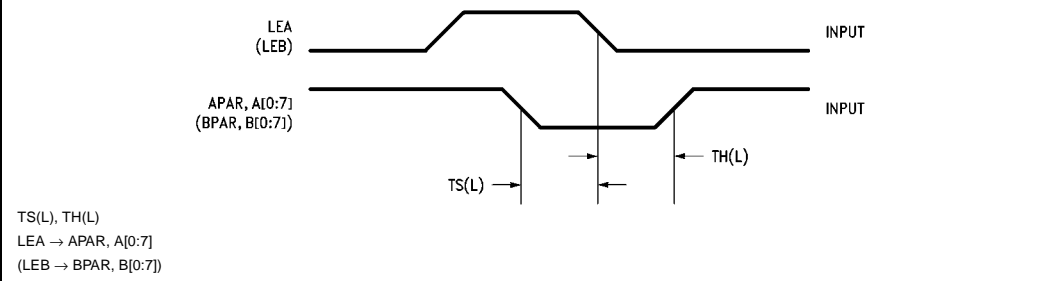

FIGURE 12.

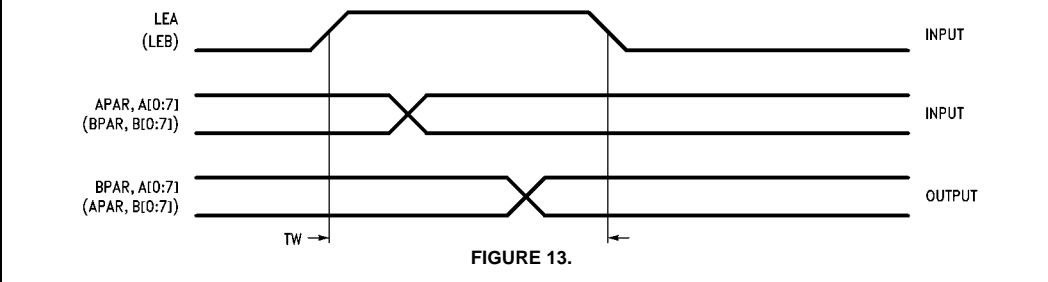

FIGURE 13.

Absolute Maximum Ratings (Note 2)		Sink Current	±300 mA
Supply Voltage (V_{CC})	-0.5V to +7.0V	Junction Temperature (T_J)	140°C
DC Input Diode Current (I_{IK})		Recommended Operating Conditions	
$V_I = -0.5V$	-20 mA	Supply Voltage (V_{CC})	4.5V to 5.5V
$V_I = V_{CC} + 0.5V$	+20 mA	Input Voltage (V_I)	0V to V_{CC}
DC Input Voltage (V_I)	-0.5V to $V_{CC} + 0.5V$	Output Voltage (V_O)	0V to V_{CC}
DC Output Diode Current (I_{OK})		Operating Temperature (T_A)	-40°C to +85°C
$V_O = -0.5V$	-20 mA	Minimum Input Edge Rate $\Delta V/\Delta t$	125 mV/ns
$V_O = V_{CC} + 0.5V$	+20 mA	V_{IN} from 0.8V to 2.0V	
DC Output Voltage (V_O)	-0.5V to $V_{CC} + 0.5V$	V_{CC} @ 4.5V, 5.5V	
DC Output Source		Note 2: Absolute maximum ratings are those values beyond which damage to the device may occur. The databook specifications should be met, without exception, to ensure that the system design is reliable over its power supply, temperature, and output/input loading variables. Fairchild does not recommend operation of FACT™ circuits outside databook specifications.	
or Sink Current (I_O)	±50 mA		
DC V_{CC} or Ground Current			
per Output Pin (I_{CC} or I_{GND})	±50 mA		
Storage Temperature (T_{STG})	-65°C to +150°C		
DC Latch-Up Source or			

DC Electrical Characteristics

Symbol	Parameter	V_{CC} (V)	$T_A = +25^\circ\text{C}$		$T_A = -40^\circ\text{C to } +85^\circ\text{C}$		Units	Conditions
			Typ	Guaranteed Limits				
V_{IH}	Minimum HIGH Level Input Voltage	4.5	1.5	2.0	2.0	V	$V_{OUT} = 0.1V$ or $V_{CC} - 0.1V$	
		5.5	1.5	2.0	2.0			
V_{IL}	Maximum LOW Level Input Voltage	4.5	1.5	0.8	0.8	V	$V_{OUT} = 0.1V$ or $V_{CC} - 0.1V$	
		5.5	1.5	0.8	0.8			
V_{OH}	Minimum HIGH Level Output Voltage	4.5	4.49	4.4	4.4	V	$I_{OUT} = -50 \mu A$	
		5.5	5.49	5.4	5.4			
		4.5		3.86	3.76	V	$V_{IN} = V_{IL}$ or V_{IH} $I_{OH} = -24 \text{ mA}$ $I_{OH} = -24 \text{ mA (Note 3)}$	
		5.5		4.86	4.76			
V_{OL}	Maximum LOW Level Output Voltage	4.5	0.001	0.1	0.1	V	$I_{OUT} = 50 \mu A$	
		5.5	0.001	0.1	0.1			
		4.5		0.36	0.44	V	$V_{IN} = V_{IL}$ or V_{IH} $I_{OL} = 24 \text{ mA}$ $I_{OL} = 24 \text{ mA (Note 3)}$	
		5.5		0.36	0.44			
I_{IN}	Maximum Input Leakage Current	5.5		±0.1	±1.0	μA	$V_I = V_{CC}, \text{GND}$	
I_{OZ}	Maximum 3-STATE Leakage Current	5.5		±0.5	±5.0	μA	$V_I = V_{IL}, V_{IH}$ $V_O = V_{CC}, \text{GND}$	
I_{CCT}	Maximum I_{CC} /Input	5.5	0.6		1.5	mA	$V_I = V_{CC} - 2.1V$	
I_{OLD}	Minimum Dynamic	5.5			75	mA	$V_{OLD} = 1.65V \text{ Max}$	
I_{OHD}	Output Current (Note 4)	5.5			-75	mA	$V_{OHD} = 3.85V \text{ Min}$	
I_{CC}	Maximum Quiescent Supply Current	5.5		8.0	80.0	μA	$V_{IN} = V_{CC}$ or GND	

Note 3: Maximum of 9 outputs loaded; thresholds on input associated with output under test.

Note 4: Maximum test duration 2.0 ms, one output loaded at a time.

AC Electrical Characteristics									
Symbol	Parameter	V _{CC} (V) (Note 5)	T _A = +25°C C _L = 50 pF			T _A = -40°C to +85°C C _L = 50 pF		Units	Fig. No.
			Min	Typ	Max	Min	Max		
t _{PLH} t _{PHL}	Propagation Delay A _n , B _n to B _n , A _n	5.0	2.5	7.5	11.5	2.5	12.0	ns	Figure 1
t _{PLH} t _{PHL}	Propagation Delay APAR, BPAR to BPAR, APAR	5.0	1.5	6.0	8.5	1.5	9.0	ns	Figure 1
t _{PLH} t _{PHL}	Propagation Delay A _n , B _n to BPAR, APAR	5.0	2.5	8.5	12.0	2.5	12.5	ns	Figure 2
t _{PLH} t _{PHL}	Propagation Delay A _n , B _n to $\overline{\text{ERRA}}$, $\overline{\text{ERRB}}$	5.0	2.0	8.0	11.5	2.0	12.0	ns	Figure 3
t _{PLH} t _{PHL}	Propagation Delay ODD/ $\overline{\text{EVEN}}$ to $\overline{\text{ERRA}}$, $\overline{\text{ERRB}}$	5.0	2.0	8.0	11.5	2.0	12.0	ns	Figure 4
t _{PLH} t _{PHL}	Propagation Delay ODD/ $\overline{\text{EVEN}}$ to APAR, BPAR	5.0	2.5	8.0	11.5	2.5	12.0	ns	Figure 5
t _{PLH} t _{PHL}	Propagation Delay APAR, BPAR to $\overline{\text{ERRA}}$, $\overline{\text{ERRB}}$	5.0	1.5	7.5	10.5	1.5	11.5	ns	Figure 6
t _{PLH} t _{PHL}	Propagation Delay $\overline{\text{SEL}}$ to APAR, BPAR	5.0	1.5	6.5	9.0	1.5	9.5	ns	Figure 9
t _{PLH} t _{PHL}	Propagation Delay LEB to A _n , B _n	5.0	2.5	7.0	10.5	2.5	11.0	ns	Figure 10 Figure 11
t _{PLH} t _{PHL}	Propagation Delay LEA to APAR, BPAR	5.0	2.0	8.0	11.5	2.0	12.0	ns	Figure 10 Figure 11
t _{PLH} t _{PHL}	Propagation Delay LEA, LEB to $\overline{\text{ERRA}}$, $\overline{\text{ERRB}}$	5.0	2.5	8.0	11.5	2.5	12.0	ns	Figure 12
t _{PZH} t _{PZL}	Output Enable Time G $\overline{\text{BA}}$ or $\overline{\text{GAB}}$ to A _n , B _n	5.0	2.5	7.0	10.5	2.5	11.0	ns	Figure 7 Figure 8
t _{PZH} t _{PZL}	Output Enable Time G $\overline{\text{BA}}$ or $\overline{\text{GAB}}$ to BPAR or APAR	5.0	1.5	6.0	9.0	1.5	9.5	ns	Figure 7 Figure 8
t _{PHZ} t _{PHL}	Output Disable Time G $\overline{\text{BA}}$ or $\overline{\text{GAB}}$ to A _n , B _n	5.0	1.5	6.5	9.5	1.5	9.5	ns	Figure 7 Figure 8
t _{PHZ} t _{PLZ}	Output Disable Time G $\overline{\text{BA}}$ or $\overline{\text{GAB}}$ to BPAR, APAR	5.0	1.5	6.5	9.5	1.5	9.5	ns	Figure 7 Figure 8

Note 5: Voltage Range 5.0 is 5.0V ± 0.5V.

AC Operating Requirements

Symbol	Parameter	V _{CC} (V) (Note 6)	T _A = +25°C C _L = 50 pF	T _A = -40°C to +85°C C _L = 50 pF	Units	Fig. No.
			Guaranteed Minimum			
t _S	Setup Time, HIGH or LOW A _n , B _n , PAR to LEA, LEB	5.0	3.0	3.0	ns	Figure 11 Figure 12
t _H	Hold Time, HIGH or LOW A _n , B _n , PAR to LEA, LEB	5.0	1.5	1.5	ns	Figure 11 Figure 12
t _W	Pulse Width for LEB, LEA	5.0	4.0	4.0	ns	Figure 13

Note 6: Voltage Range 5.0 = 5.0V ± 0.5V.

Capacitance

Symbol	Parameter	Typ	Units	Conditions
C _{IN}	Input Capacitance	4.5	pF	V _{CC} = 5.0V
C _{PD}	Power Dissipation Capacitance	210	pF	V _{CC} = 5.0V

Physical Dimensions inches (millimeters) unless otherwise noted

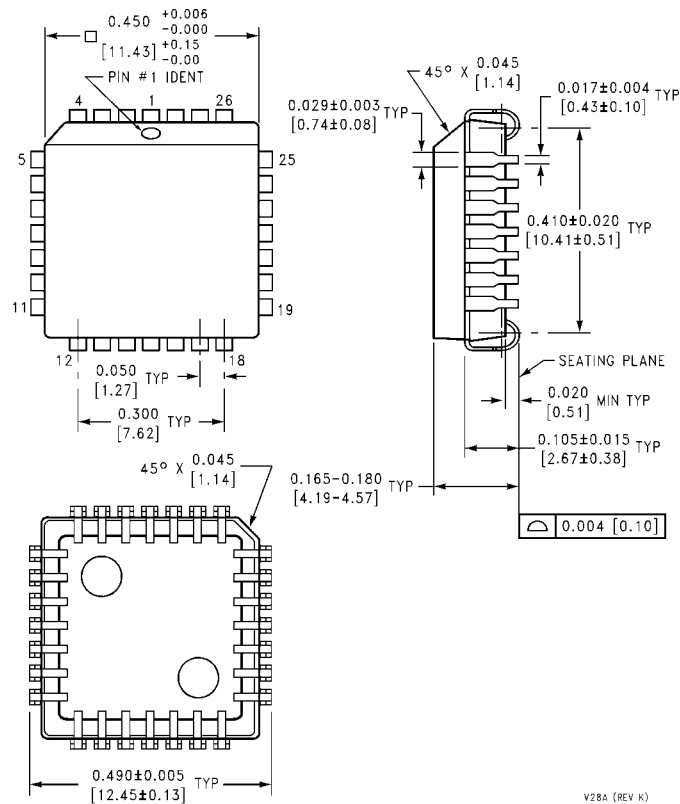

**28-Lead Plastic Lead Chip Carrier (PLCC), JEDEC MO-047, 0.450" Square
Package Number V28A**

LIFE SUPPORT POLICY

FAIRCHILD'S PRODUCTS ARE NOT AUTHORIZED FOR USE AS CRITICAL COMPONENTS IN LIFE SUPPORT DEVICES OR SYSTEMS WITHOUT THE EXPRESS WRITTEN APPROVAL OF THE PRESIDENT OF FAIRCHILD SEMICONDUCTOR CORPORATION. As used herein:

1. Life support devices or systems are devices or systems which, (a) are intended for surgical implant into the body, or (b) support or sustain life, and (c) whose failure to perform when properly used in accordance with instructions for use provided in the labeling, can be reasonably expected to result in a significant injury to the user.
2. A critical component in any component of a life support device or system whose failure to perform can be reasonably expected to cause the failure of the life support device or system, or to affect its safety or effectiveness.

www.fairchildsemi.com