



Transponder Coils

TPL series

TPL802727

TPL1183427

TPL1183525

REMINDERS FOR USING THESE PRODUCTS

Before using these products, be sure to request the delivery specifications.

SAFETY REMINDERS

Please pay sufficient attention to the warnings for safe designing when using these products.

REMINDERS

- The storage period is less than 12 months. Be sure to follow the storage conditions (Temperature: 5 to 40°C, Humidity: 10 to 75% RH or less).
If the storage period elapses, the soldering of the terminal electrodes may deteriorate.
- Do not use or store in locations where there are conditions such as gas corrosion (salt, acid, alkali, etc.).
- Before soldering, be sure to preheat components.
The preheating temperature should be set so that the temperature difference between the solder temperature and chip temperature does not exceed 150°C.
- Soldering corrections after mounting should be within the range of the conditions determined in the specifications.
If overheated, a short circuit, performance deterioration, or lifespan shortening may occur.
- When embedding a printed circuit board where a chip is mounted to a set, be sure that residual stress is not given to the chip due to the overall distortion of the printed circuit board and partial distortion such as at screw tightening portions.
- Self heating (temperature increase) occurs when the power is turned ON, so the tolerance should be sufficient for the set thermal design.
- Use a wrist band to discharge static electricity in your body through the grounding wire.
- Do not expose the products to magnets or magnetic fields.
- Do not use for a purpose outside of the contents regulated in the delivery specifications.
- If an ultrasonic process is used, thoroughly check the condition setting in order to prevent disconnection.
- Do not clean the products with solvents. If a potting resin or a moisture-proof coat containing a solvent such as acetone, toluene or xylene is used, consult with us in advance.
- The products listed on this catalog are intended for use in general electronic equipment (AV equipment, telecommunications equipment, home appliances, amusement equipment, computer equipment, personal equipment, office equipment, measurement equipment, industrial robots) under a normal operation and use condition.
The products are not designed or warranted to meet the requirements of the applications listed below, whose performance and/or quality require a more stringent level of safety or reliability, or whose failure, malfunction or trouble could cause serious damage to society, person or property.
If you intend to use the products in the applications listed below or if you have special requirements exceeding the range or conditions set forth in the each catalog, please contact us.

<ul style="list-style-type: none"> (1) Aerospace/Aviation equipment (2) Transportation equipment (electric trains, ships, etc.) (3) Medical equipment (4) Power-generation control equipment (5) Atomic energy-related equipment (6) Seabed equipment (7) Transportation control equipment 	<ul style="list-style-type: none"> (8) Public information-processing equipment (9) Military equipment (10) Electric heating apparatus, burning equipment (11) Disaster prevention/crime prevention equipment (12) Safety equipment (13) Other applications that are not considered general-purpose applications
---	---

When designing your equipment even for general-purpose applications, you are kindly requested to take into consideration securing protection circuit/device or providing backup circuits in your equipment.

• All specifications are subject to change without notice.

Transponder Coils

Product compatible with RoHS directive
AEC-Q200

Overview of the TPL Series

FEATURES

Common in the series

Transponder coils that ensure high reliability suitable for automotive applications. TPL802727 type coils also realize a small size (8 mm in length) and high inductance (18.52mH max.)

Achieves stable electrical characteristics due to their high SRF design structure.

TPL802727 type

Ensures high reliability suitable for automotive applications by adopting higher heat resistance wire and welding wire connection.

TPL1183427, TPL1183525 types

It is fully resin-molded.

Terminals are highly reliable with the spring structure. They show excellent quality especially in bending and drop resistance.

APPLICATION

Mainly receiving LF antenna coils for the in-car devices shown below

Tire-pressure monitoring system (TPMS)

Keyless entry system

Immobilizer etc.

Other electronic devices

PART NUMBER CONSTRUCTION

TPL		802727		-	722		H	
Series name	LxWxH Dimensions (mm)		Inductance (mH)		Inductance tolerance (%)			
	802727	8.0x2.7x2.7		722	7.2	H	±3	
1183427	11.8x3.4x2.75				J	±5		
1183525	11.8x3.5x2.4							

OPERATING TEMPERATURE RANGE, PACKAGE QUANTITY, PRODUCT WEIGHT

Type	Temperature range		Package quantity (pieces/reel)
	Operating temperature*	Storage temperature	
	(°C)	(°C)	
TPL802727	-40 to +125	-40 to +125	2,500
TPL1183427	-40 to +125	-40 to +125	2,500
TPL1183525	-40 to +125	-40 to +125	2,500

* Operating temperature range includes self-temperature rise.

RoHS Directive Compliant Product: See the following for more details related to RoHS Directive compliant products. <http://www.tdk.co.jp/rohs/>

All specifications are subject to change without notice.

TPL series

TPL802727 Type



SHAPE & DIMENSIONS

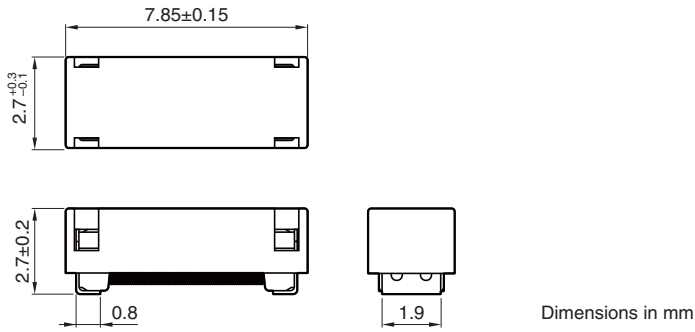

RECOMMENDED LAND PATTERN

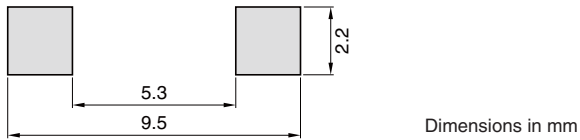

• All specifications are subject to change without notice.

TPL series **TPL802727 Type**

■ ELECTRICAL CHARACTERISTICS

□ CHARACTERISTICS SPECIFICATION TABLE

L* (mH)	Tolerance	Q min.	Measurement frequency (kHz)	DC resistance (Ω)		Part No.
				max.		
18.52	$\pm 3\%$	40	125	240		TPL802727-193H
7.20	$\pm 3\%$	35	125	105		TPL802727-722H
4.91	$\pm 3\%$	30	125	85		TPL802727-492H
4.50	$\pm 3\%$	30	125	80		TPL802727-452H

* This inductance value is an example of the current commercial product. If a different inductance is needed, please contact us.

TPL series **TPL802727 Type**

■ ELECTRICAL CHARACTERISTICS

□ L FREQUENCY CHARACTERISTICS GRAPH

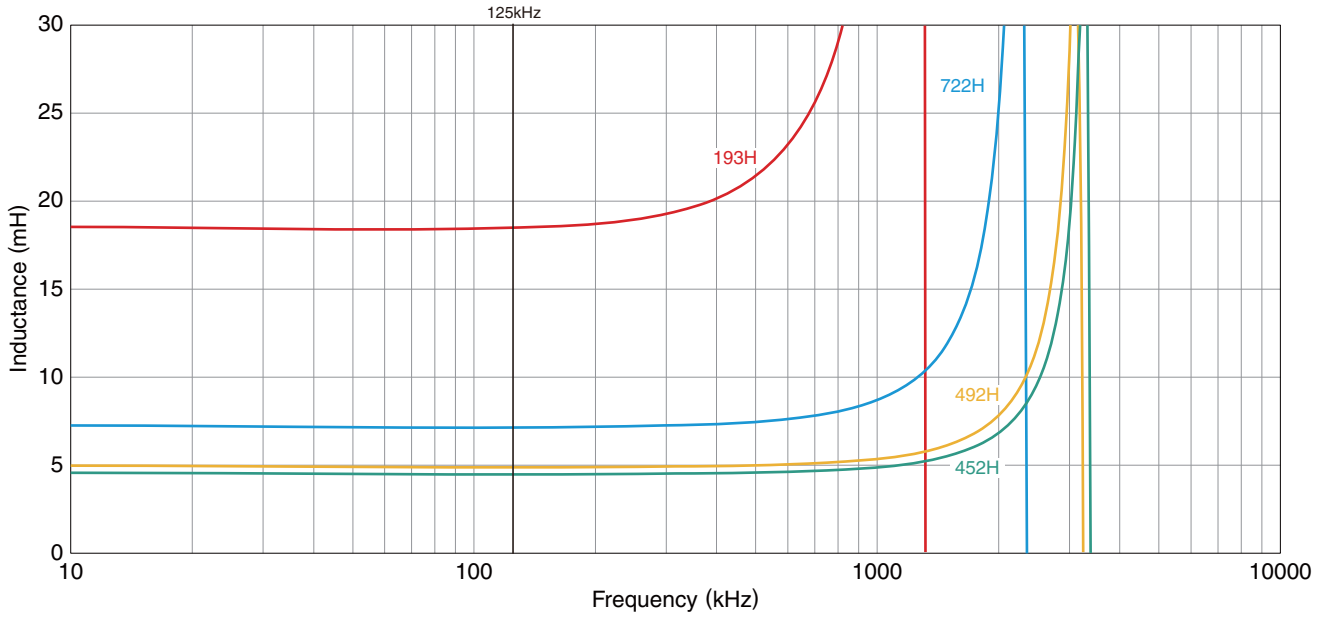

□ Q FREQUENCY CHARACTERISTICS GRAPH

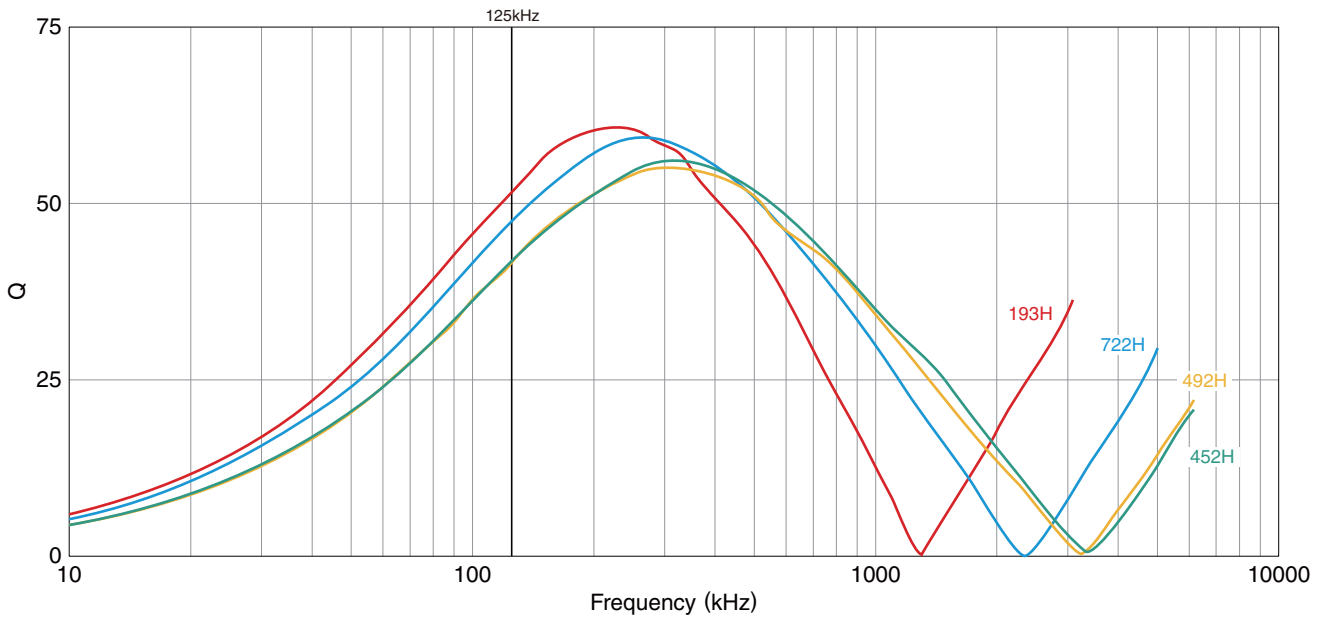

• All specifications are subject to change without notice.

TPL series

TPL1183427 Type



■ SHAPE & DIMENSIONS

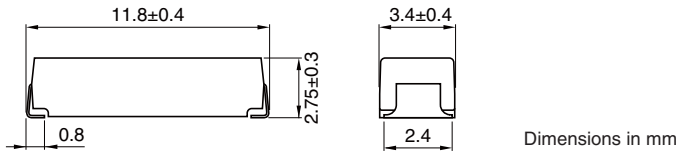

■ RECOMMENDED LAND PATTERN

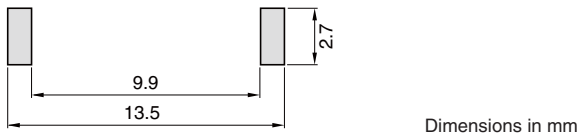

TPL series **TPL1183427 Type**

■ ELECTRICAL CHARACTERISTICS

□ CHARACTERISTICS SPECIFICATION TABLE

L* [125kHz] (mH)	Tolerance	Q [125kHz] typ.	Self-resonant frequency (kHz) typ.	DC resistance (Ω) typ.	Part No.
7.20	$\pm 5\%$	66	690	50	TPL1183427-722J-720N

* This inductance value is an example of the current commercial product. If a different inductance is needed, please contact us.

* Available for an inductance tolerance of less than $\pm 5\%$.

○ Measurement equipment

Measurement item	Product No.	Manufacturer
L, Q	4194A+16047E	Agilent Technologies
Self-resonant frequency	4194A+16047E	Agilent Technologies
DC resistance	AX-114N	ADEX

* Equivalent measurement equipment may be used.

TPL series TPL1183427 Type

ELECTRICAL CHARACTERISTICS

L FREQUENCY CHARACTERISTICS GRAPH

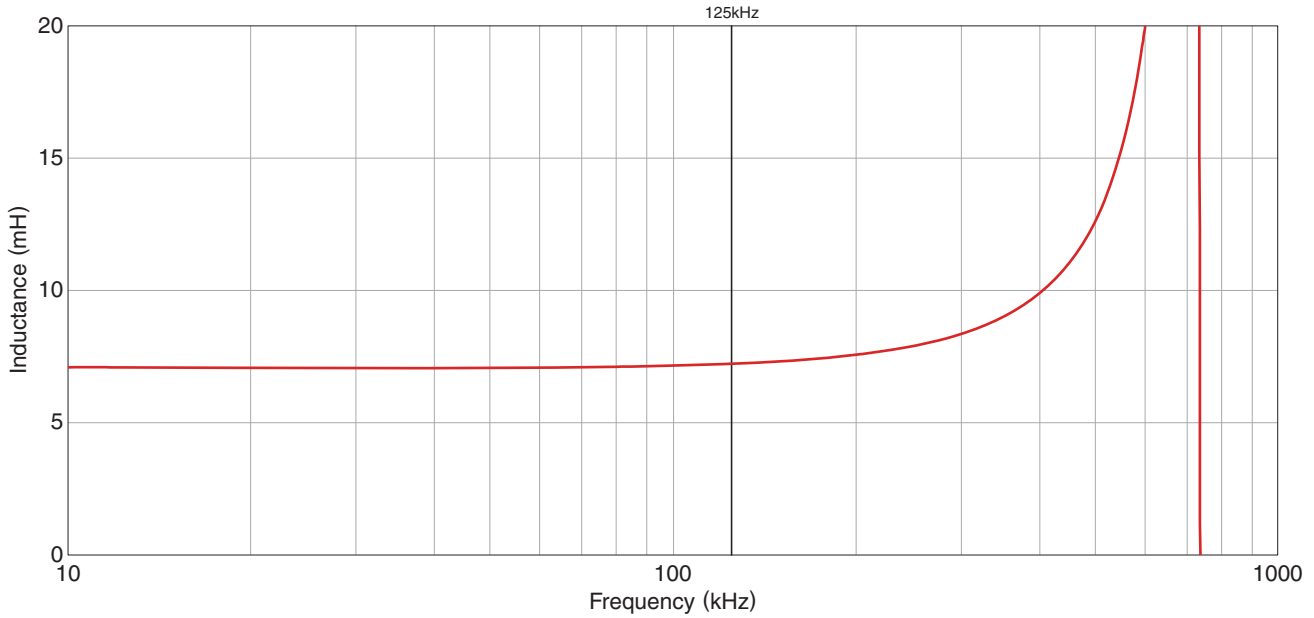

○ Measurement equipment

Product No.	Manufacturer
4194A+16047E	Agilent Technologies

* Equivalent measurement equipment may be used.

Q FREQUENCY CHARACTERISTICS GRAPH

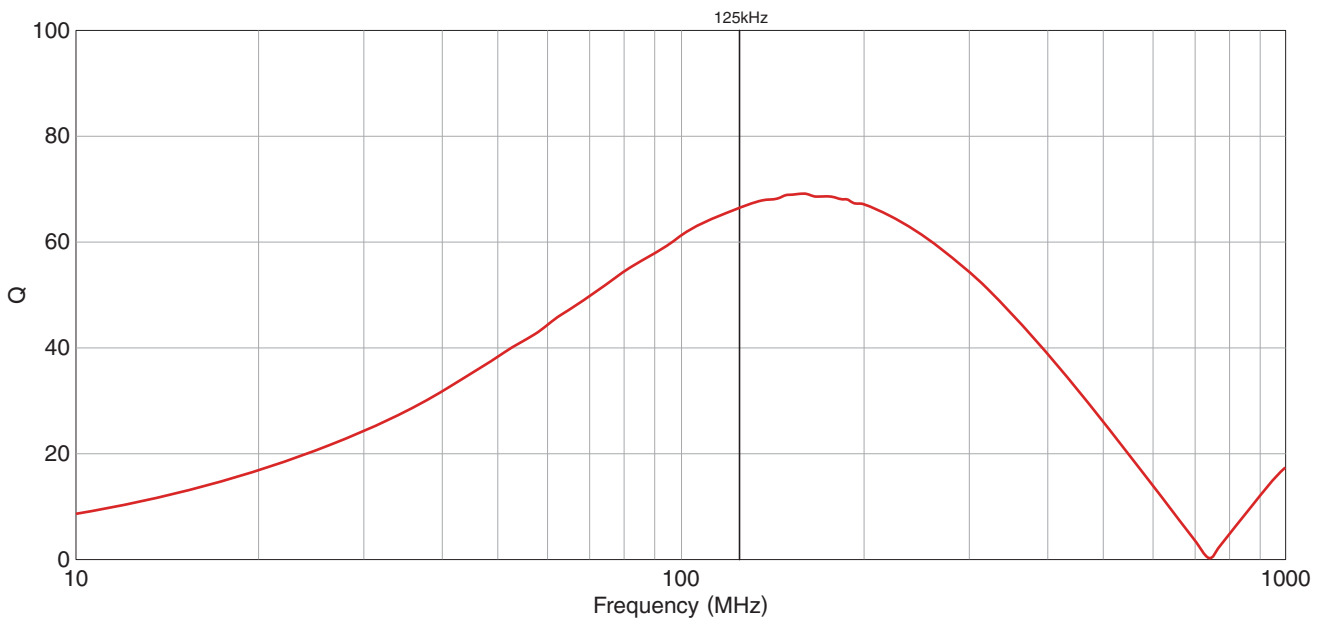

○ Measurement equipment

Product No.	Manufacturer
4194A+16047E	Agilent Technologies

* Equivalent measurement equipment may be used.

• All specifications are subject to change without notice.

TPL series

TPL1183525 Type



SHAPE & DIMENSIONS

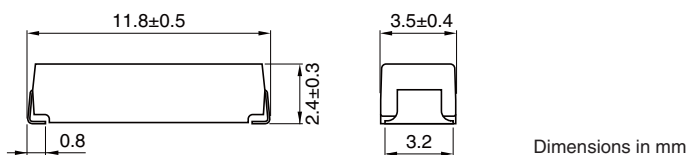

RECOMMENDED LAND PATTERN

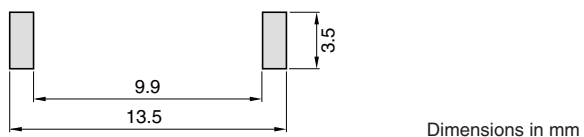

• All specifications are subject to change without notice.

TPL series **TPL1183525 Type**

■ ELECTRICAL CHARACTERISTICS

□ CHARACTERISTICS SPECIFICATION TABLE

L* [125kHz] (mH)	Tolerance	Q [125kHz] typ.	Self-resonant frequency (kHz) typ.	DC resistance (Ω) typ.	Part No.
2.61	$\pm 5\%$	50	650	26	TPL1183525-262J-261N
2.36	$\pm 3\%$	53	1100	24	TPL1183525-242Y-236N

* This inductance value is an example of the current commercial product. If a different inductance is needed, please contact us.

* Available for an inductance tolerance of less than $\pm 5\%$.

○ Measurement equipment

Measurement item	Product No.	Manufacturer
L, Q	4194A+16047E	Agilent Technologies
Self-resonant frequency	4194A+16047E	Agilent Technologies
DC resistance	AX-114N	ADEX

* Equivalent measurement equipment may be used.

TPL series TPL1183525 Type

ELECTRICAL CHARACTERISTICS

L FREQUENCY CHARACTERISTICS GRAPH

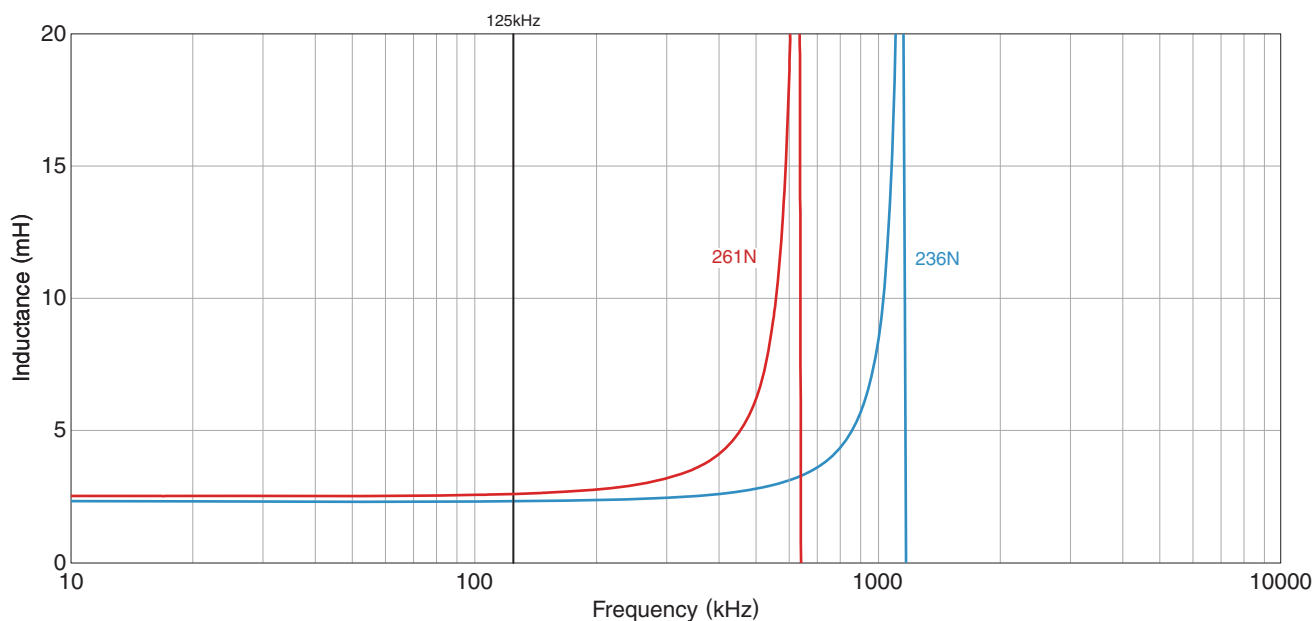

○ Measurement equipment

Product No.	Manufacturer
4194A+16047E	Agilent Technologies

* Equivalent measurement equipment may be used.

Q FREQUENCY CHARACTERISTICS GRAPH

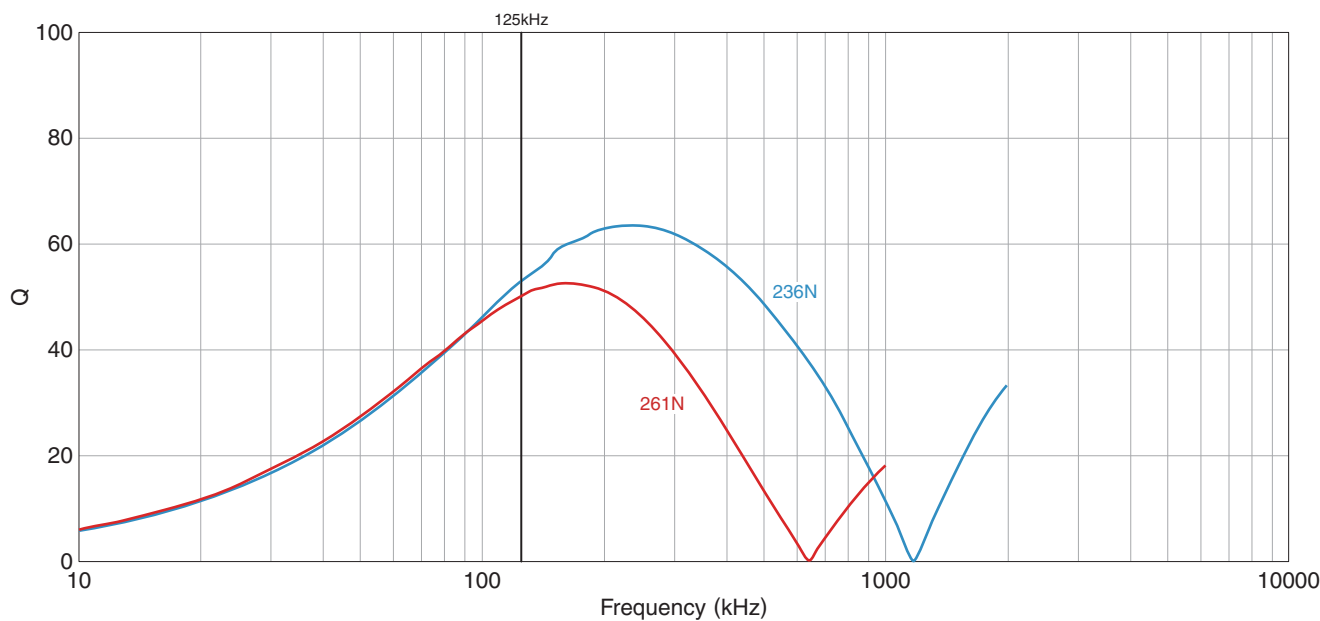

○ Measurement equipment

Product No.	Manufacturer
4194A+16047E	Agilent Technologies

* Equivalent measurement equipment may be used.

• All specifications are subject to change without notice.

TPL series

Packaging style

REEL DIMENSIONS

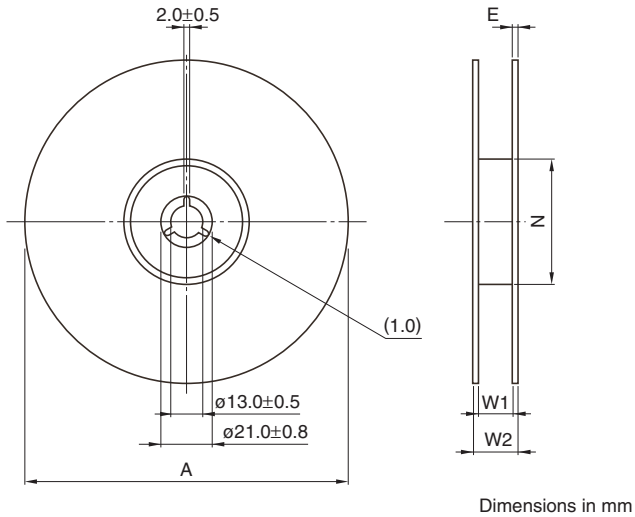

Type	A	W1	W2	N	E
TPL802727	$\phi 329+0.5/-1.5$	21.4 ± 1.0	17.4 ± 1.0	$\phi 100\pm 1.0$	2
TPL1183427	$\phi 330\pm 2.0$	$24.4+2.0/-0$	29 ± 2.0	$\phi 80$ or $\phi 100\pm 1.0$	2
TPL1183525	$\phi 330\pm 2.0$	$24.4+2.0/-0$	29 ± 2.0	$\phi 80$ or $\phi 100\pm 1.0$	2

TAPE DIMENSIONS

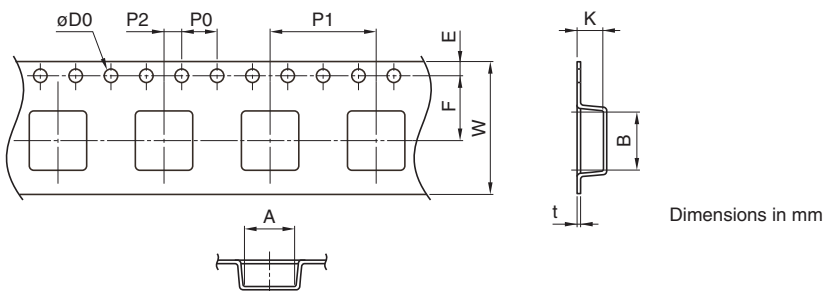

Dimensions in mm

Type	A	B	$\phi D0$	E	F	P0	P1	P2	W	K	t
TPL802727	3.0	8.1	$1.5+0.1/-0$	1.75 ± 0.1	7.5 ± 0.1	4.0 ± 0.1	8.0 ± 0.1	2.0 ± 0.1	16.0 ± 0.3	2.9	0.3
TPL1183427	3.7	12.1	1.55 ± 0.05	1.75 ± 0.1	11.5 ± 0.1	4.0 ± 0.1	8.0 ± 0.1	2.0 ± 0.1	24 ± 0.3	3.2	0.3
TPL1183525	3.7	12.1	1.55 ± 0.05	1.75 ± 0.1	11.5 ± 0.1	4.0 ± 0.1	8.0 ± 0.1	2.0 ± 0.1	24 ± 0.3	2.8	0.3

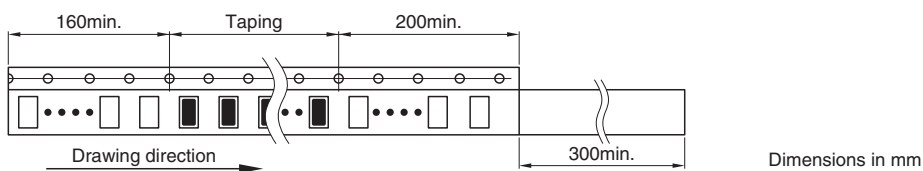

• All specifications are subject to change without notice.